

KODAK PIXPRO AZ422

DIGITAL CAMERA

User Manual



BEFORE YOU START

Declaration of Conformity

Responsible Party: JK Imaging Ltd.

Address: JK Imaging Ltd., 17239 So. Main Street, Gardena, CA 90248 USA

Company Website: kodakpixpro.com

For Customers in the U.S.A.

Tested to Comply with FCC Standards FOR HOME OR OFFICE USE

This device complies with part 15 of the FCC Rules. Operation is subject to the following two conditions: (1) This device may not cause harmful interference and (2) this device must accept any interference received, including interference that may cause undesired camera operation.

For Customers in Europe

 "CE" mark indicates that this product complies with the European requirements for safety, health, environment and customer protection. "CE" marked cameras are intended for sales in Europe.

 This symbol [crossed-out wheel bin WEEE Annex IV] indicates separate collection of electrical waste and electronic equipment in the European countries. Please do not throw the equipment into domestic refuse. Please use the return and collection systems available in your country for proper, safe disposal of this product.

 Batteries: Please dispose of used batteries at designated collection centers.

 Packaging: Please follow local regulations for the recycling of packaging.

About this Manual

Thank you for purchasing this KODAK PIXPRO Digital Camera. Please read this manual carefully and keep it in a safe place for future reference.

- JK Imaging reserves all rights of this document. No part of this published manual may be reproduced, transmitted, transcribed, stored in a retrieval system or translated into any language or computer language, in any form, by any means, without the prior written permission of JK Imaging.
- All trademarks mentioned in this manual are used for identification purposes only and are properties of their respective owners and holders.
- This manual provides you with instructions on how to use your new KODAK PIXPRO Digital Camera. Every effort has been made to ensure that the contents of this manual are accurate; however JK Imaging reserves the right to make changes without notice.
- Throughout this manual, the following symbols are used to help you locate information quickly and easily:



Indicates useful information.

- The following symbols may be used throughout this manual to facilitate your understanding of how to operate the camera:

[Item properties]:The optional properties in the camera interface are indicated by the [] symbol.

SAFETY NOTES

Safety Notes for this Camera

- Do not drop the camera or allow it to hit solid objects.
- Do not attempt to disassemble or repair the camera.
- Do not use or store the camera in dusty places or on a beach to help prevent dust or sand from entering the camera, causing possible damage.
- Do not use or store the camera in a hot environment or in direct sunlight.
- Do not use or store the camera near powerful magnetic fields, for example near a magnet or transformer.
- Avoid touching the lens of the camera.
- Do not expose the camera to direct sunlight for a long period of time.
- To prevent the camera from being damaged by moisture, do not use or store the camera in very humid environments, such as in rain or near bodies of water.
- If water accidentally comes in contact with the camera, turn the camera off immediately, remove the battery and the memory card and dry it completely within 24 hours.
- When you take the camera from a cold environment to a warmer environment, condensation may occur. Please wait for a reasonable period of time before you turn the camera on.
- Before you remove the battery and memory card, the camera should be turned off.
- When you clean the body of the camera, do not use abrasive, alcohol-based or organic cleansers or solvents.
- Use a professional lens cleaning cloth and appropriate cleaner to wipe and clean the lens.
- Download your photos and remove the memory card when you are going to store the camera for long periods of time.
- If this camera is not in use for a long period of time, please keep it in a dry and clean storage location.
- Our company will not pay compensation for any failure of playback including: pictures or videos damaged or unrecoverable by improper operation.

Safety Notes for Battery

- Please use a battery that is the same type as the one included.
- Please use the attached charger to charge the battery.
- If battery fluid leaks inside the camera, contact our customer service department immediately. If battery fluid leaks onto your skin, rinse your skin with clean water and seek immediate medical attention.
- Disposal of used batteries should be carried out in accordance with your local (national or regional) regulations.
- To prevent the battery from being damaged, do not drop the battery or allow it to hit solid objects or to be scratched by foreign objects.
- Do not let the battery come in contact with metal objects (including coins) to avoid short circuiting, discharging, excessive heat or possible leakage.
- Do not attempt to disassemble the battery.
- Do not expose the battery to water. Always keep the battery contacts dry.
- Do not heat the battery or throw it into a fire to avoid a possible explosion.
- Do not store the battery in a hot environment or in direct sunlight.
- If the battery overheats during charging or use, stop charging or use immediately. Turn off the product, remove the battery carefully and wait until it cools down.
- When the camera is stored for a long period of time, remove the battery and keep it in a safe, dry place that is not accessible to infants and children.
- In colder environments, the performance of the battery could be noticeably reduced.
- When you install the battery, align the battery markings according to the positive and negative markings inside the camera battery compartment. Never force the battery into the battery compartment.

Safety Notes for Memory Cards

- We highly suggest buying only well-known, name brand memory cards to ensure peak performance and reliability.
- Format the memory card using the camera before you use it or insert a new one.
- Do not drop the memory card or allow it to hit solid objects to avoid damaging it.
- Do not attempt to disassemble or repair the memory card.
- Do not expose the memory card to water. Always keep it dry.
- Do not remove the memory card when the camera is turned on. Otherwise, the memory card and photo/video files could be permanently damaged.
- Do not directly edit the data on the memory card. Copy the data to your computer before you edit the files.
- When the camera is stored for long periods of time, be sure to download your photos and remove the memory card. Store the memory card in a dry environment.
- Do not modify the name of the files or folders of the memory card using your computer. Modifying the file names may cause the files to not be recognized on the camera or a possible permanent error may occur.
- A photo taken with the camera will be stored in the folder that is automatically generated on the memory card. Do not store photos that are not taken using this camera in these folders as the pictures cannot be recognized during playback.
- When you insert the memory card, make sure the notch of the card matches the markings on the top of the camera card slot.

Other Safety Notes

- Do not disconnect the power or turn the camera off during the update process. Doing so may cause incorrect data to be written and the camera may not power on later.
- Do not hang the neck strap of the camera around the neck of a child.
- When using your camera on an airplane, observe the relevant rules specified by the airline and FAA regulations.
- Due to the limitations of manufacturing technology, the LCD may have a few dead or bright pixels. These pixels do not affect the quality or performance of the camera, photos or video.
- Do not expose the camera's LCD to water. In a humid environment, only wipe it with a soft, dry, cleaning cloth.
- If the LCD screen is damaged, pay particular attention to the liquid crystal in the screen. If any of the following situations arise, immediately take the steps listed below:
 1. If liquid crystal comes in contact with your skin, please wipe with a dry cloth, wash thoroughly with soap, and rinse with plenty of clean water.
 2. If liquid crystal gets into your eye, flush the eye immediately with plenty of clean water for at least 15 minutes and then seek medical assistance.
 3. If liquid crystal is swallowed, immediately rinse your mouth thoroughly with clean water and induce vomiting. Seek medical assistance.

Trademark Information

- The terms HDMI, HDMI High-Definition Multimedia Interface, HDMI Trade dress and the HDMI Logos are trademarks or registered trademarks of HDMI Licensing Administrator, Inc.



CONTENTS

BEFORE YOU START	1
SAFETY NOTES	3
CONTENTS	7
GETTING READY	11
Accessories Included	11
Installing Lens Cap and Neck Strap	12
Part Names	13
Installing Battery and Memory Card	15
Charging Battery	17
Turning Camera On and Off	19
How to Take Pictures	19
Set your Language, Date/Time	20
MODE OVERVIEW	22
Display Setting	22
LCD Screen Display	23
Overview of the Screen Icons in Photo Shooting Mode	23
Overview of the Screen Icons in Movie Mode	25
Overview of the Screen Icons in Playback Mode	26

Using the Mode Dial.....	27
Auto Mode.....	28
Program AE	29
Shutter Priority.....	29
Aperture Priority	30
Manual Mode	30
Face Beautifier	31
Panorama Mode.....	32
Scene Mode	33
Custom Settings	37
BASIC OPERATION.....	39
Using the Zoom Function	39
Focus Setting	40
Macro Mode	41
Self-Timer Setting	42
Flash Mode	43
White Balance Setting	44
Continuous Shot.....	45
EV Setting.....	46
Using Quick Recording.....	48
"i" Button Function Menu.....	49

PLAYBACK	50
Viewing Photos and Videos	50
Thumbnail View	51
Using Zoom Playback (for still pictures only)	52
Deleting Photos and Videos	53
Slideshow	54
USING THE MENUS	55
Photo Setup Menu	55
Photo Shooting Setting Menu	60
Movie Menu	64
Movie Setting Menu	66
Playback Menu	68
“i” Button Playback Function	73
Playback Setting Menu	74
Setup Menu	78
Sound Settings	79
Power Saver	79
Language	80
World Time	80
Date/Time	80

LCD Brightness.....	80
File Settings	81
Format Memory.....	81
Copy to Card	82
File Numbering.....	82
Reset	83
Firmware (FW) Version	83
CONNECTIONS.....	84
Connecting to a Computer	84
Video System	86
Set Eye-Fi Card Connection Mode.....	87
Supported HDMI Connections.....	88
Connecting to a PictBridge Compatible Printer.....	89
Using the PictBridge Menu.....	91
APPENDICES	95
Specifications	95
Prompts and Warning Messages.....	99
Troubleshooting.....	103

GETTING READY

Accessories Included

Your camera box should contain the camera model you purchased along with the following accessories. If anything is missing or appears to be damaged, please contact your retailer first or our customer service center. (The battery chargers may be a little different in shape due to the difference of countries or regions this type of cameras are sold to, and are subject to matching the physical product).

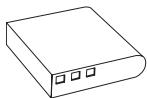

Rechargeable
Li-ion battery

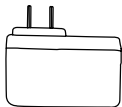

AC Adapter
(Optional)

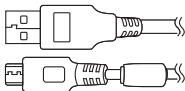

Micro USB Cable



Neck Strap

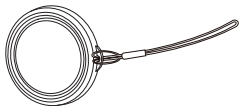

Lens Cap with Cord



Quick Start Guide



Warranty Card



Service Card

Installing Lens Cap and Neck Strap

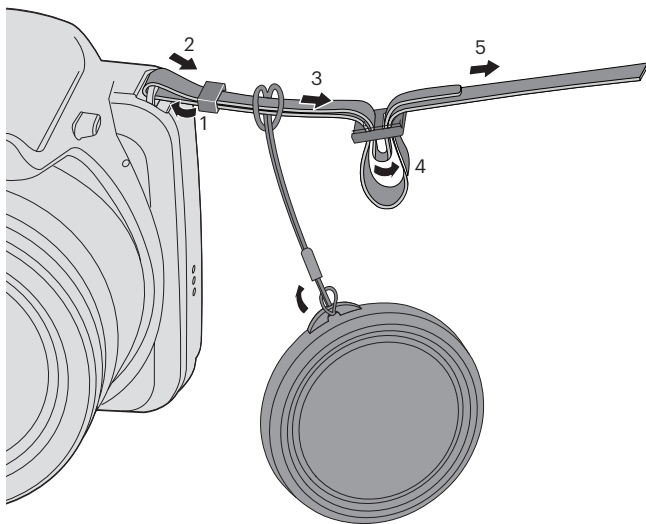

Part Names

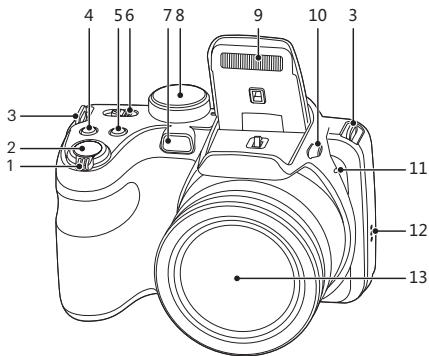

1. Zoom Lever
2. Shutter Button
3. Strap Eyelet
4. Exposure Compensation Button
5. Continuous Shot Button
6. Power Switch
7. AF Assist Beam/Self-Timer Lamp
8. Mode Dial
9. Flash Lamp
10. Flash Button
11. Microphone
12. Speaker
13. Lens

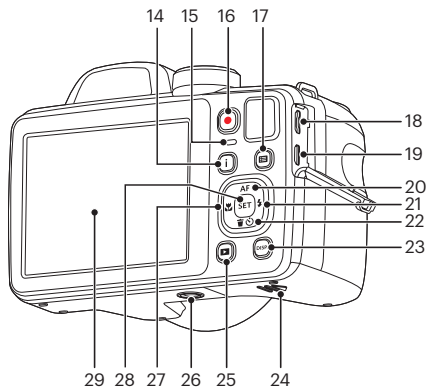

- 14. “i” Button
- 15. Indicator Lamp
- 16. Fast Video Recording Button
- 17. Menu Button
- 18. Micro USB/AV Port
- 19. Micro HDMI Port
- 20. AF Button/Arrow Button (Up)
- 21. Flash Button/Arrow Button (Right)
- 22. Delete Button/Self-Timer Button/
Arrow Button (Down)
- 23. Display Button
- 24. Battery Cover
- 25. Playback Button
- 26. Tripod Socket
- 27. Macro Button/Arrow Button (Left)
- 28. SET Button
- 29. LCD

Installing Battery and Memory Card

1. Open the battery cover door according to diagram (①,②) below:

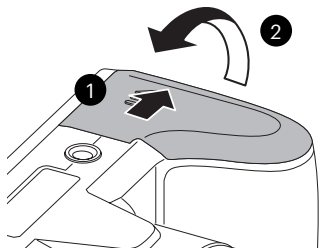

2. Insert the battery into the battery slot in the correct direction as shown in the following diagram.

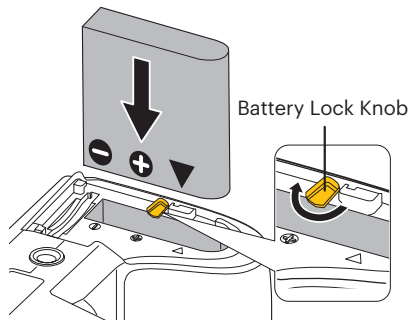

3. Insert the memory card into the memory card slot as shown in the diagram below:

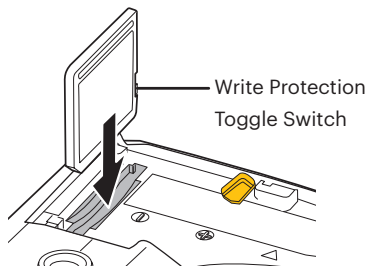

4. Close the battery cover door according to instructions ① and ② below:

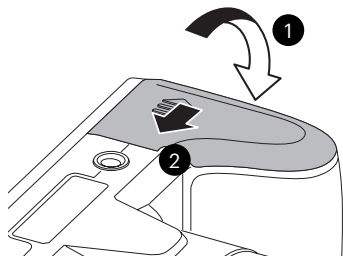



- ① A standard SD memory card is not included in the camera packaging and needs to be purchased separately. This camera takes a standard (SD/SDHC) memory card. We recommend using a name brand memory card that is Class 4 or higher and has a capacity of 4GB to 32GB. The camera is not compatible with Micro SD, Ultra, Ultra Plus, Extreme, XC, or adapters for any of these other memory cards.
- ② To remove your memory card, open the battery cover door, gently press the memory card to eject it and remove carefully.

Charging Battery

Before you charge your battery, you should turn the camera off and insert the battery.

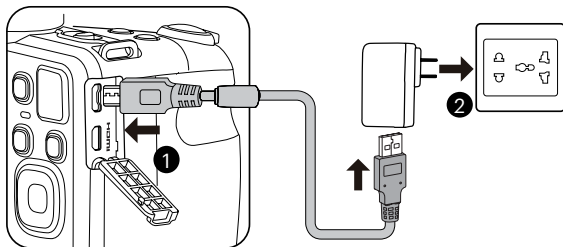
1. Connect the camera to the power charger using the supplied USB cable
2. Insert the plug of the power charger into the wall outlet to charge the battery.



 The charger is for indoor use only.

 After the battery is stored for long periods of time, use the supplied power charger to fully charge the battery prior to use.

3. When the camera is turned off, you can also connect the camera to your computer using a Micro USB cable to charge the battery.

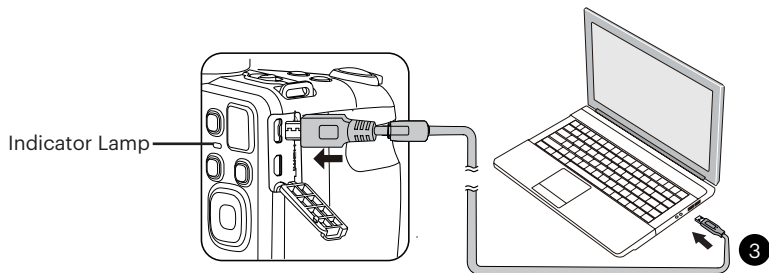

Charging indicator:

Orange: Charging

The indicator lamp will go out once charging is finished.

To maximize battery life, charge the battery for at least 4 hours the first time.



Please charge the battery indoors between 0°C and 40°C (32°F and 104°F).

Turning Camera On and Off

Press the Power button to turn the camera on. To turn the camera off, press the Power button again.

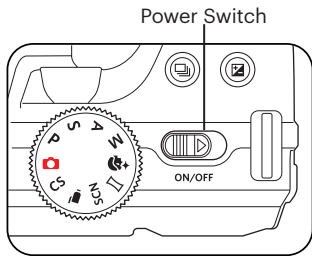

When the power is off, press and hold the play button to power on and enter Playback mode.

How to Take Pictures

1. Hold the camera securely with both hands, being careful not to block the flash and lens with fingers.
2. Point the lens toward the object you want to take a picture of.
3. Use the zoom lever to select Tele or Wide position to zoom in or out on your subject.
4. Press the shutter button down half-way to allow the camera to focus on your subject.
5. When the frame around your subject turns green and the LCD is focused to your liking, push the shutter button down completely to take the picture.

Set your Language, Date/Time

Set your Language, Date/Time after the First Power-On

1. When you turn the camera on for the first time, the language selection screen will appear.
 2. Press the arrow buttons to select your desired language.
 3. After you press the **SET** button to confirm the your language selection, the Date/ Time settings screen will appear.
 4. Press the left/right arrow buttons to select the Date/Time to be adjusted: Time is displayed in YYYY.MM.DD/HH:MM.
 5. Press the up/down arrow buttons to adjust the value for the desired Date/ Time.
 6. Press the **SET** button to confirm the time settings and the snapshot screen will appear.
2. Press the **SET** button and press the up/ down arrow buttons to select **SET**. Press the **SET** button to enter the menu.
 3. Press the up/down arrow buttons to select **SET** and press the **SET** button or right arrow button to enter the menu.
 4. Press the up/down arrow buttons to select [Language] and press the **SET** button or right arrow button to enter the menu.
 5. Press the arrow buttons to select your desired language and press the **SET** button to confirm.
 6. Press the **SET** button and the snapshot screen will appear.

Resetting your Language

After you set your language for the first time, follow the instructions below to reset your desired language.



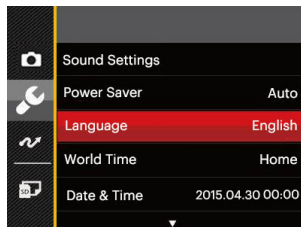



1. Turn the power switch to turn on the camera.







Resetting Date/Time

After you set your Date/Time for the first time, follow the instructions below to reset date and time.

1. Turn the power switch to turn on the camera.
2. Press the  button and press the up/down arrow buttons to select . Press the  button to enter the menu.
3. Press the up/down arrow buttons to select , and press the  button or right arrow button to enter the menu.
4. Press the up/down arrow buttons to select [Date & Time] and press the  button or right arrow button to enter the menu.
5. Press the left/right arrow buttons to select the Date/Time to be adjusted: Time is displayed in YYYY.MM.DD/ HH:MM.

6. Press the up/down arrow buttons to press the value for your selected entry. After you finish your settings, press the  button to confirm.
7. Press the  button and the following snapshot screen will appear.

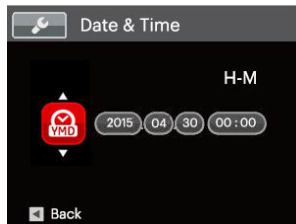
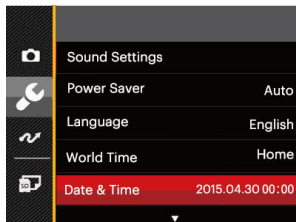

MODE OVERVIEW

Display Setting

Press the **[DISP]** button to display the settings:
Classic, Full, Off.

Classic: Displays the camera parameters on screen

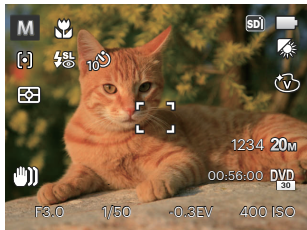

Full: Camera parameters with Grid and Histogram

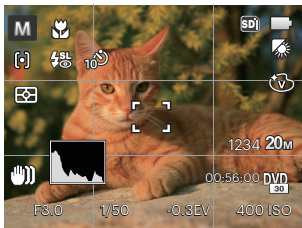

Off: Does not display any additional icons on screen

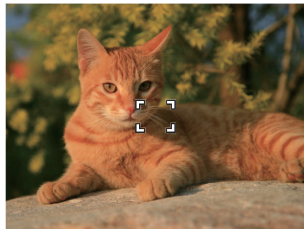

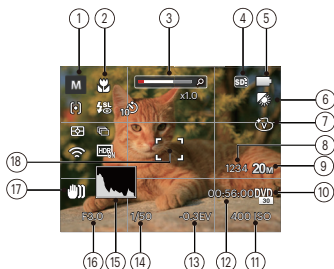

LCD Screen Display

Overview of the Screen Icons in Photo Shooting Mode





1 Shooting Mode Icons

 Auto Mode	 Face Beautifier
P Program AE	 Panorama Mode
S Shutter Priority	SCN Scene Mode
A Aperture Priority	CS Custom Settings
M Manual Mode	

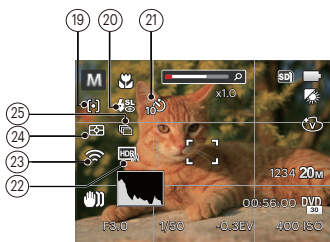





- 2 Macro Mode
- 3 Zoom Display (By turning the Zoom Lever)
- 4 SD Memory Card/Built-In Memory
- 5 Battery Status
- 6 White Balance (This can be adjusted in **P SAM** Mode)
- 7 Color Effect (This can be adjusted in **PS AM** Mode)
- 8 Number of Remaining Shots
- 9 Image Size
- 10 Video Quality
- 11 ISO Value (This can be adjusted in **PSA M+M** Mode)
- 12 Remaining Recording time
- 13 Exposure Compensation (EV Value) (This can be adjusted in **PSA +M** Mode)
- 14 Shutter Speed (This can be adjusted in **S M** Mode)
- 15 Histogram
- 16 Aperture Value (This can be adjusted in **A M** Mode)
- 17 Image Stabilization
- 18 Focus Frame







19 AF Mode

-  Single-AF
-  Multi-AF
-  Object Tracking

20 Flash Mode

-  Force Off
-  Flash Auto
-  Force Flash
-  Slow Sync.
-  Slow Sync. + Red-Eye
-  Red-Eye Reduction

21 Self-Timer

-  Self-Timer Off
-  Self-Timer 2 sec
-  Self-Timer 10 sec
-  Self-Timer Smile





22 HDR (This can be adjusted PSAM Mode)

23 Eye-Fi ON (with signal)

24 Expo Metering

-  AiAE
-  Spot
-  Center

25 Continuous Shot

-  Single
-  Continuous Shot
-  3 Shots
-  Time-Lapse (30sec/ 1min/ 5min/ 10min)

Overview of the Screen Icons in Movie Mode

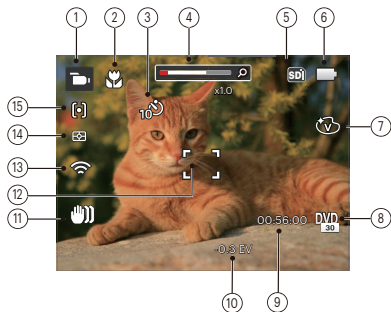

1 Movie Mode Icons

2 Macro Mode

3 Self-Timer



Self-Timer Off



Self-Timer 10 sec

4 Zoom Display (by turning the Zoom Lever)

5 SD Memory Card/Built-In Memory

6 Battery Status

7 Color Effect

8 Video Quality

9 Remaining Recording time

10 Exposure Compensation (EV Value)

11 Image stabilization

12 Focus Frame

13 Eye-Fi ON (with signal)

14 Expo Metering



AiAE



Spot



Center

15 AF Mode



For optimal video shooting, it is recommended that an SD/SDHC memory card be used. If you shoot video using only the camera's internal memory, the end results may have image jitter, noise and vastly shorter recording times.



Optical Zoom and Digital Zoom can be adjusted (168X in total). Digital Zoom can be adjusted to 4X.



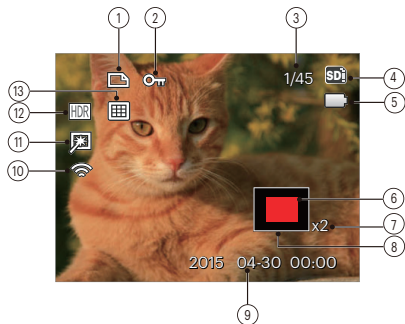

Overview of the Screen Icons in Playback Mode



1	DPOF File	8	Image Zone
2	File Protection	9	Shooting Date
3	Memory Space (indicating the current number of photos and total number of photos)	10	Eye-Fi ON (with signal)
4	SD Memory Card/Built-in Memory	11	Red-Eye Reduction
5	Battery Status	12	HDR
6	Zoom Magnification Area	13	Date Folder
7	Image Zoom Ratios		

Using the Mode Dial

This camera provides a convenient mode dial that allows you to manually switch between different modes with ease. The available modes are listed below:

Mode Name	Icon	Description
Auto Mode		In this mode, the optimal conditions for taking pictures will be set based on the subject and environment. It is the most commonly used mode for taking pictures.
Program AE	P	Under different scenes, the user can switch the ISO and EV value according to personal preference, the camera can automatically set the shutter speed and aperture value.
Shutter Priority	S	Setting allows you to choose a specific shutter speed so the camera will adjust the aperture automatically to ensure correct exposure.
Aperture Priority	A	Allows you to choose a specific aperture and the camera will automatically adjust the shutter speed to match it.
Manual Mode	M	Aperture, Shutter Speed, and ISO can be configured manually in this mode.
Face Beautifier		This mode automatically enhances facial features with skin softening touches and eye brightening capabilities.
Panorama Mode		You can take a panoramic photo in this mode (up to 180°).
Scene Mode	SCN	Choose from 12 different pre-set scene types and effects for your photos.
Movie Mode		Record videos. Press down the shutter button to start recording.
Custom Settings	CS	The user can store the frequently used shooting modes and parameters and switch to this mode for quick adjustment.

Auto Mode

Auto Mode is the most common and easiest mode to take photos. While operating in this mode, the camera automatically optimizes numerous camera settings to adjust optimum settings for your photos and videos for the best possible results.

Follow these steps:

1. Turn the power switch to turn on the camera.
2. Turn the Mode Dial to .
3. Compose your picture in the LCD screen and press the Shutter button halfway down to focus on the subject.
4. The LCD screen will show a green focus frame when the subject is in focus.
5. Press the shutter button all the way down to take your photo.

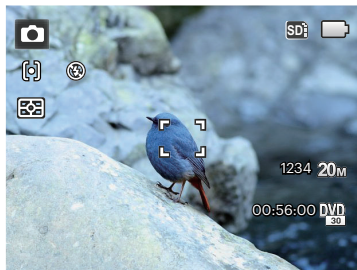

Program AE **P**

When **P** (Program AE) mode is selected, you can adjust the EV value and ISO value.

1. Turn the Mode Dial to **P** and press the  button to configure settings.

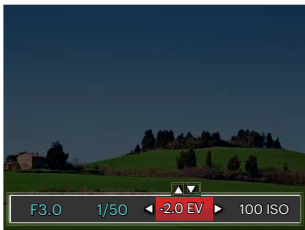



2. Press the left/right arrow buttons to select a setting to adjust.
3. Press the up/down arrow buttons to adjust the setting.
4. Press the  button to engage the settings and enter the shooting screen.

Shutter Priority **S**

When **S** (Shutter Priority) is selected, you can adjust the shutter speed, ISO value and EV value. The camera automatically sets the aperture value based on the shutter speed value and ISO value to get the most appropriate exposure value.

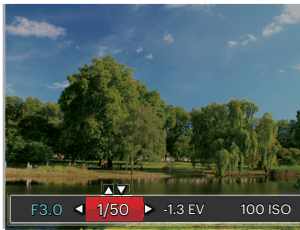
1. Turn the Mode Dial to **S** and press the  button to configure settings.



2. Press the left/right arrow buttons to select a setting to adjust.
3. Press the up/down arrow buttons to adjust the setting.
4. Press the  button to confirm the settings and enter the shooting screen.

Aperture Priority **A**

When selecting **A** (Aperture Priority) Mode, you can adjust the aperture size / EV value and ISO value. Selecting a large aperture opening will emphasize the point of focus and show a blurry background and foreground. A small aperture opening will keep both the background and main object in clear focus.

1. Turn the Mode Dial to **A** and press the  button to configure settings.



2. Press the left/right arrow buttons to select a setting to adjust.
3. Press the up/down arrow buttons to adjust the setting.
4. Press the  button to confirm the settings and enter the shooting screen.

Manual Mode **M**

When selecting Manual (**M**) Mode, you can set the aperture / shutter speed manually and ISO value.





1. Turn the Mode Dial to **M** and press the  button to configure settings.



2. Press the left/right arrow buttons to select a setting to adjust.
3. Press the up/down arrow buttons to adjust the setting.
4. Press the  button to confirm the settings and enter the shooting screen.



Face Beautifier

In Portrait Mode, the camera is set to automatically adjust camera exposure for realistic portrayal of skin tones.

1. Turn the Mode Dial to select Face Beautifier Mode ().
2. Press the  button and press the up/down buttons to select .
3. Press the left/right arrow buttons to select Face Beautifier Effects and press the  button to confirm and return to photo shooting mode.



Beautifier Mode has 3 effects:

-  Effect 1: Skin Soften
-  Effect 2: Skin Soften + Eye Brightening
-  Effect 3: Skin Soften + Eye Brightening + Eye Enlargement

Panorama Mode

With Panorama Mode, you can take a series of pictures which will be automatically stitched into an ultra-wide panoramic (up to 180°) picture by the camera.

Follow the steps below:

1. Turn the Mode dial to Panorama Mode ().
2. Press the arrow buttons to select a desired shooting direction. Should you not select a direction, the default shooting direction is "right." 2 seconds later, the camera will be ready to take pictures. You can also press the **SET** button or press the shutter button halfway down to be ready to take pictures.
3. Compose the first view of the panoramic picture on the LCD and press the Shutter button to capture the image.
4. When you finish shooting the first photo, two target icons will display on the LCD at left and right sides. Move the camera to the right until the round target icon is directly positioned over the square box. The box will turn green when they overlap and the camera will automatically take the next picture. Repeat the same steps for additional shots. Up to 4 frames can be stitched together.
5. If continuous pictures are less than 4 shots, press the **SET** button and the camera will automatically stitch the pictures together. Press the playback button to enter Playback mode to see the end effect.
6. If you take 4 pictures, the camera will automatically stitch the pictures together. Press the playback button to enter Playback mode to see the finished effect.

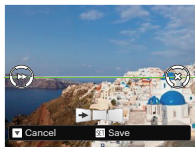

- Flash Mode, Self-Timer, Macro Mode, and Exposure Compensation are all disabled in Panorama Mode.
- In the process of shooting in Panorama Mode, when the LCD shows "Improper alignment. Please try again," it means that in the process of the camera moving, the angle is off the green line and stitching cannot be completed. You will have to try again, keeping the LCD image aligned with the green line.
- In order to guarantee the best shooting effect in Panorama Mode, please keep moving horizontally and keep unnecessary shaking to a minimum.
- In Panorama Mode, up to 4 photos can be captured when the image size is set at 2MP.







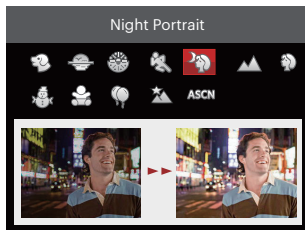





Scene Mode SCN

You can select your desired scene from the 12 Scene modes according to the type of environment you are shooting in. The camera then automatically configures the most appropriate settings for the best possible photos.

Turn the Mode Dial to the Scene Mode to enter the Scene Mode menu. What the LCD screen displays is shown in the screen shot below:









Press the arrow buttons to select a scene, and press the **SET** button to confirm.

Scene	Description
 Pet Mode	Rapidly identifies a pet (dog/cat), capturing the dynamic movement of pets.
 Sunset	For sunsets. Captures subjects in strong sunlight.
 Fireworks	For fireworks at night. The use of a tripod is recommended with this setting.
 Sport	For fast-moving subjects. Captures sharp, action shots with minimal blur. This mode is not recommended for shooting indoors.
 Night Portrait	For taking portraits against night scenery.
 Landscape	For landscapes and outdoor shots. Vivid reproduction of greens and blues.
 Portrait	Most suitable for capturing people, focusing on their face.
 Snow	For snowy conditions. Reproduces natural, clear, white scenes.
 Children	Turns flash off automatically. Avoids disturbing the subjects and is suitable for taking photos of children and pets.
 Party	Suitable for taking indoor party pictures, even under complicated lighting conditions.
 Night Landscape	For night scenes. The use of a tripod is recommended with this setting.
 Auto Scene	Identifies the scene automatically; Person, Backlighting, Landscape, Macro, Night Scene, Night Scene Person and Auto.

Auto Scene Mode (ASCN)

In "ASCN" Scene Mode, the camera can intelligently detect different environments and automatically select the best scene and photo settings for you.

"ASCN" can intelligently detect the following scenes:





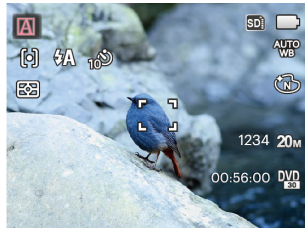

Icon	Mode Name
	Landscape Mode
	Portrait Mode
	Night Portrait
	Backlit Portrait
	Night Landscape Mode
	Macro Mode
	Auto Mode

To use "ASCN":

1. Turn the Mode Dial to "SCN" and select "ASCN" Mode.



2. Hold the camera steadily and aim at the subject. The optimum scene mode will be selected automatically.
3. Press the Shutter Button halfway to focus on the subject.
4. Press the Shutter Button all the way down to take pictures.

Mode Name	Description
 Landscape Mode	For landscapes, automatically adjusts the exposure and reproduces vivid green and blue colors.
 Portrait Mode	Most suitable for capturing people with focus on their faces.
 Night Portrait	When you take portraits at night or in low light conditions, automatically adjusts the exposure for people and night scenes.
 Backlit Portrait	When the sun or any other light source is behind you, automatically adjusts the foreground exposure to produce the best pictures possible.
 Night Landscape Mode	For night scenes, automatically increases the ISO value to compensate for low light.
 Macro Mode	The Macro setting is ideal for shooting small objects or close-up photos.
 Auto Mode	The camera automatically adjusts the exposure and focus to ensure the best possible pictures.

Custom Settings CS

The user can store frequently used shooting modes and parameters, and switch to this mode for a quick adjustment. Changing these settings will override any previous settings in CS mode.

Settings under CS mode:

1. Turn the Mode dial to select the **CS** mode and enter the setup screen as shown in the figure below:

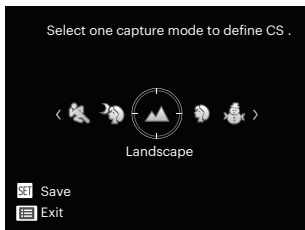

2. As shown in the figure above, press the left/right arrow buttons to select the capture mode that you want to define as **CS** and press the **SET** button to enter the shooting screen.

3. As shown in the figure above, press the **SET** button and choose whether to continue the **CS** mode setting or rotate the Mode dial to skip.

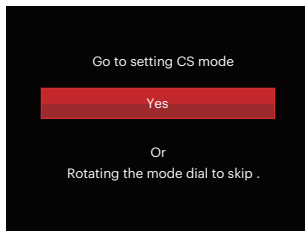

Settings under non-CS mode:

1. Select any mode or scene mode to be stored.
2. Set your desired parameters in the current mode.
3. Press the **SET** button, press the up/down arrow buttons to select **SET**, and press the **SET** button to enter the menu.
4. Press the up/down arrow buttons to select **SET**, and press the **SET** button or right arrow button to enter the menu.



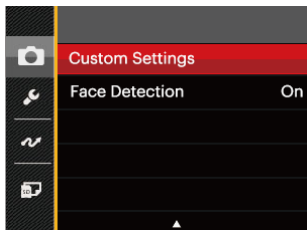

5. Press the down arrow button select [Custom Settings] and press the  button or the right arrow button to enter the menu.

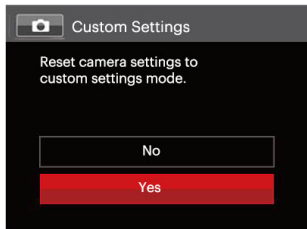

6. Select [Yes] to save or [No] to cancel.



7. Turn the Mode dial to switch to the custom settings (**CS**).
8. The photo settings you stored the last time are used.

-  When the **CS** mode is used for the first time, there is no preset parameter stored in the **CS** mode.
-  Under the non **CS** mode, if you need to retain or modify the set parameters (except the parameters in ) in restart or all modes. Please enter the [Custom Settings] menu and select [Yes] after setup. Otherwise, the parameter settings are not retained in the case of switching on/off or mode switching.
-  If you want to remove the parameter setting of [Custom Settings], please see the reset function on page 83 to operate.

BASIC OPERATION

Using the Zoom Function

Your camera is equipped with two types of zoom functions: Optical Zoom and Digital Zoom. Toggle the Zoom Lever of the camera to zoom in or out on the subject while taking pictures.

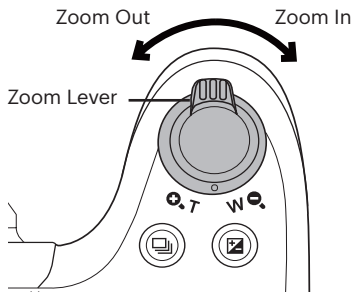

Zoom Indicator

When the Optical Zoom reaches the threshold as Digital Zoom, release and turn the Zoom lever to T to switch between the Optical Zoom and Digital Zoom.

Focus Setting

In different photo shooting modes, you can select different focus methods.

1. Press the up arrow button (**AF**) to display the settings screen.
3. Press the **SET** button to confirm the settings and exit the menu.



2. Press the left/right to select the following 3 modes:



Single-AF: The focus frame appears on the center of the LCD screen to focus on the subject.



Multi-AF: The camera automatically focuses the subject in a wide area to find the focus point.



Object Tracking: Smart tracking of the object in motion under the focusing shooting.



Once enabled, Object Tracking will only work when lens is focused on the object.



Macro Mode

The Macro Setting is ideal for shooting small objects or close-up photos. This mode allows you to focus on subjects very close to the camera.

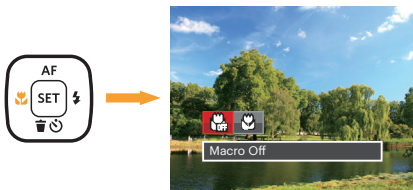
1. Press the left arrow button () to enter the Macro Menu.





2. Press the left/right to select the following 2 modes:

-  Macro Off
Select this option to disable Macro.
-  Macro On
Select this option to make focusing on the object closer to the lens (At the W side, the shooting distance should be more than 1.6 cm).

3. Press the  button to confirm the settings and exit the menu.



Self-Timer Setting

Using this function to take pictures at pre-set intervals. The camera can be set to shoot after 2 seconds, 10 seconds after pressing the shutter or when a smile is detected.

1. Press the down arrow button ( ) to enter the self-Timer menu.





2. Press the left/right to select the following 4 modes:



-  Self-Timer Off
Disables the Self-Timer.
-  Self-Timer 2 sec
A single picture is shot 2 seconds after the Shutter Button is pressed.

-  Self-Timer 10 sec
A single picture is shot 10 seconds after the Shutter Button is pressed.

-  Self-Timer Smile
Press the Shutter Button and a picture will be taken immediately after a smile is detected.

3. Press the  button to confirm the settings and exit the menu.

-  When enabling the Self-Timer, pressing the shutter or the down arrow button can disable the Self-Timer and return to the shooting screen while keeping the Self-Timer setting.

-  When enabling the Smile Detection setting, pressing the shutter button or  button can disable the Self-Timer without keeping the Self-Timer-Smile setting.

Flash Mode

The flash provides supplemental light for a scene. The flash is usually used when shooting against the light to highlight the object. It is also suitable for metering and shooting in darker scenes to improve the exposure.



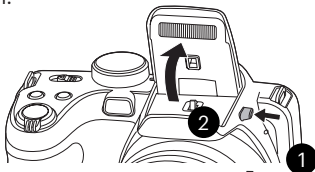



1. Press the Flash Button  to pop up the flash.



2. Press the right arrow button () to enter the Flash Settings Menu.



3. Press the left/right to select the following 6 modes:

-  Force Off
Flash is turned off.
-  Flash Auto
Camera flash goes off automatically based on existing light conditions.
-  Force Flash
The flash will engage with each shot even if there is enough available light to take the photo without flash.
-  Slow Sync.
This allows you to take pictures of people at night that clearly show both your subjects and the night time backdrop. The use of a tripod is recommended when shooting with this setting.
-  Slow Sync. + Red-Eye
Use this mode for slow synchro shots with red-eye reduction.
-  Red-Eye Reduction
The camera emits a brief pre-flash before the picture is taken to reduce red-eye effects.

4. Press the  button to confirm the settings and exit.





White Balance Setting

The white balance function allows adjustment of the color temperature for different light sources (This can be adjusted in **PSAM** Mode).

Follow the steps below to set white balance of the camera:

1. Press **SET** button to enter White Balance Menu.



-  Fluorescent
-  Fluorescent CWF
-  Incandescent
-  Manual WB (Fully press the shutter button to detect the white balance value)
-  Color Temp. (1900K-10000K)
Press direction buttons Up / Down to "Adjust the K value";
Press the direction button Left to exit the K value.

2. Press the left/right to select the following 8 modes:

-  AUTO WB AWB
-  Daylight
-  Cloudy

3. Press the **SET** button to confirm the settings and exit the menu.



Continuous Shot

Follow the steps below to configure the Continuous Shot Settings:

1. Press the  to enter the Continuous Shot Menu.



2. Press the left/right to select the following 4 modes:

-  Single
-  Continuous Shot
-  3 Shots

-  Time-Lapse
Take pictures based on the preset interval (30sec/ 1min/ 5min/ 10min).

3. Press the  button to confirm the settings and exit the menu.
4. Press the Shutter button to start continuous shooting.

-  The flash is disabled in this mode in order to achieve quick succession of shots.

EV Setting

The EV Function Menu of the camera includes functions, such as EV (Exposure Value) Adjustment, ISO, Shutter Adjustment, Aperture Adjustment, etc. Using the appropriate Function Settings can improve your pictures.

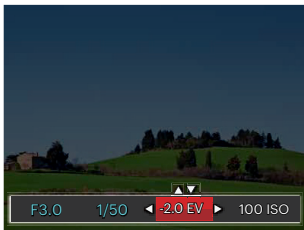

To select the best setting follow these steps:

1. Press the  button to display the Settings screen.
2. Press the left/right arrow buttons to select the Setting options.



3. Press the up/down buttons to adjust the option values.
4. Press the  button to complete the setting and enter shooting mode.

Exposure Compensation

Set up Exposure Compensation to adjust the picture brightness. If there is very high contrast between the photographed object and the background, the brightness of the picture can be adjusted as necessary. (This can be adjusted in **PSA**   Mode)

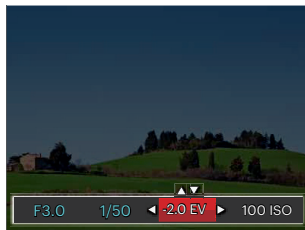

The adjustable range of exposure value is from EV -2.0 to EV +2.0.

ISO

The ISO function allows you to set the sensitivity of the camera's light sensor based on the brightness of the scene. To improve the camera's sensor performance in darker environments, a higher ISO value is required. A lower ISO value is needed when shooting in brighter conditions.

Pictures taken at higher ISO settings will generally have more noise than those taken at lower ISO settings. (This can be adjusted in **PSAM** Mode)



The camera's ISO settings include: Auto, 80, 100, 200, 400, 800, 1600 and 3200.

Shutter Adjustment

For shutter speed, the camera may automatically set the aperture value corresponding to the manually set shutter speed to obtain the most suitable exposure value. The movement of an object may be shown by adjusting the shutter speed. A higher shutter value can help you more clearly capture fast moving objects, while a lower shutter value can better show the movement of objects. (This can be adjusted in **SM** Mode)



Aperture Adjustment

You can adjust the aperture size value. Selecting a large aperture opening will emphasize the point of focus and show a blurry background and foreground. A small aperture opening will keep both the background and main object in clear focus. (This can be adjusted in **AM** Mode)



Using Quick Recording

In Photo Shooting Mode, press the Recording Shortcut Button  to begin recording video.

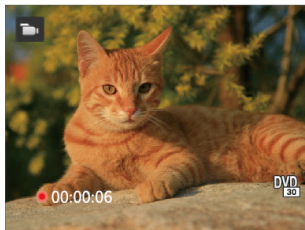

Once you are finished, press the Recording Shortcut Button or the shutter button to stop and store the video. The camera will automatically return to the current Shooting Mode set.

"i" Button Function Menu



Mode: **PSAM** 



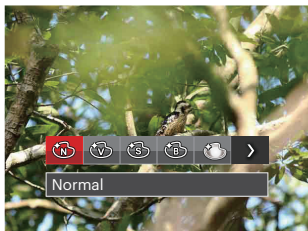

The Image Color Setting allows you to select different color effects.

1. Press the  button to select the Image Color Setting Menu.
2. Press the left/right arrow buttons to select the Image Color Setting options.







There are 7 Image Color options in Photo Shooting Mode **PSAM**:

-  Normal
-  Vivid

-  Sepia
-  Black and White
-  Vignetting
-  Salon
-  Dreamy

There are 4 Image Color options in Movie Mode :

-  Normal
-  Vivid
-  Sepia
-  Black and White

PLAYBACK

Viewing Photos and Videos

To view photos and videos on LCD screen:

1. After pressing the **[]** button, the last photo or video clip taken will be displayed on the LCD screen.
2. Use the Left/Right navigation buttons to scroll through the photos or video clips stored in the internal memory or on the SD Memory Card.
3. To play a selected video clip, press the **[SET]** button to enter the Movie Playback Mode. An operation guide appears on the screen when playing back a video. Press the appropriate buttons to enable the corresponding functions.

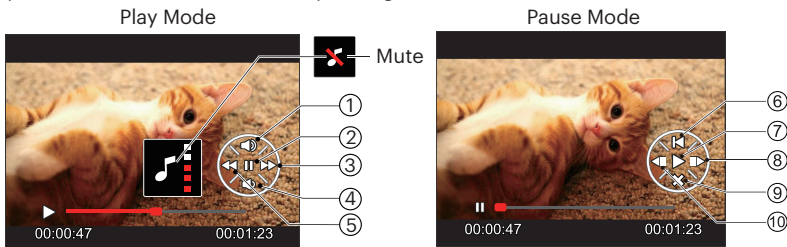

1	Increase Volume
2	Pause
3	Fast Forward
4	Decrease Volume
5	Rewind

6	Return Back to the Beginning of the Video
7	Play
8	Play Video Forward
9	Cancel Playback
10	Play Video Backward

Thumbnail View

When in Playback Mode, rotate the Zoom Lever counter clockwise to the **W** position to display thumbnail images of the photos and videos on the screen. (the picture is displayed in horizontal position)

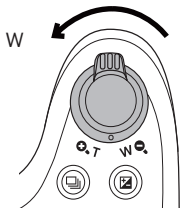

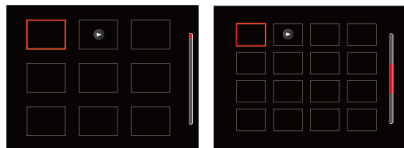

1. Slide the Zoom Lever to switch between 3 x 3 and 4 x 4 thumbnails.
2. When a 3 x 3 or 4 x 4 thumbnail is displayed, press the arrow buttons to select a picture or video clip to view.





3. Press the arrow buttons to select a picture or video clip to view and press the **SET** button to restore it to the original size.
- If the  indicator appears on the LCD, then a movie file is currently being displayed.

Using Zoom Playback (for still pictures only)

When playing back photos, you can also use the Zoom Slider to zoom in on the photos 2 to 8 times their original magnification.

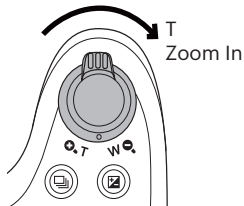
1. Press the  button to switch to Playback Mode.
2. Press the left/right arrow buttons to select the picture on which to use the zoom feature.
3. Rotate the Zoom Lever clockwise to () to zoom in.
4. The bottom right corner of the screen will display the number of times the image is magnified and area of the photo shown.



5. Press the arrow buttons to navigate and select a portion of the photo to be zoomed in on.
6. Press the  button to return the image to its original scale.



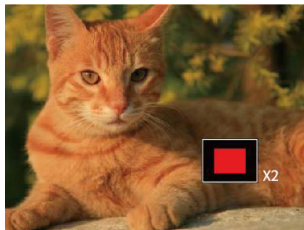

Movie images cannot be magnified.



Deleting Photos and Videos

In Playback Mode, press the down arrow button () to delete your photos and videos.

To delete photos or videos:

1. Press the  button to switch to Playback Mode.
2. Press the left/right arrow buttons to select the photos and videos to be deleted.
3. Press the down arrow button () and the deletion screen is displayed.

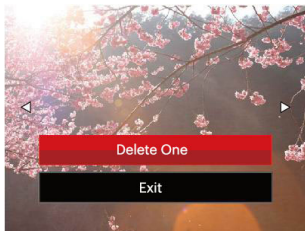

4. Press the up/down arrow buttons to select [Delete One] or [Exit] and press the  button to confirm.





Erased photos/video clips cannot be recovered.







Please refer to page 76 for instructions on deleting more than one image at a time.

Slideshow

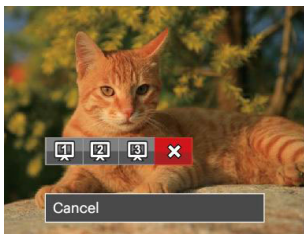
You can use this setting to view all of the stored pictures as a slideshow.

1. Press the  button to enter playback screen.
2. Press the  button to enter the slide option (except for video file).
3. Press the left/right buttons to select slideshow playing or [Cancel] to return to the playback screen.





4. Press the  button to confirm the setting.
-  Pictures scroll automatically during a slide show.
 -  Slide playing function supports movie playing.

USING THE MENUS

Photo Setup Menu

Mode:  **PSAM** +  **SCN**

1. In Photo Shooting Mode, press the  button to enter the Photo Shooting Menu.
2. Press the up/down arrow buttons to select the Photo Shooting Menu to be set.
3. Press the left/right arrow buttons to select the Photo Shooting Menu to be set and press the  button to confirm.



Refer to the following pages 55 to 58 for more details about each setting.

Expo Metering (Exposure Metering)

Use this setting to select the "target" size of the camera's field of view to be metered.



There are 3 options:

- **AiAE (Artificial Intelligence AE):** Automatically selects the central and peripheral metering, to calculate the reasonable value of metering by weighting.
- **Spot:** Metering targets a small area in the center of the camera's field of view.
- **Center:** Metering targets a slightly larger area in the center of the camera's field of view.

Image Size

The Size setting refers to the image resolution in pixels. A higher image resolution allows you to print that image in larger sizes without degrading the image photo quality.

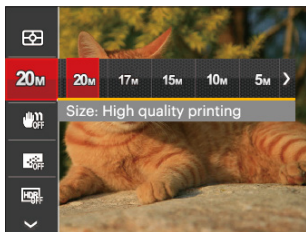

- ① The bigger the number of recorded pixels is, the better the image quality becomes. As the number of recorded pixels lessen, you will be able to record more images on a memory card.

OIS (Optical Image Stabilization)

This mode can help reduce photo blur caused by unintentional shaking or low light.



- ① Use the Image Stabilization Mode in darker environments.
- ① Shooting in a windy or unstable environment (such as a moving vehicle) may cause blurry images.

Continuous AF (Auto-Focus)

Use Continuous AF setting to be able to continuously focus automatically when taking pictures.

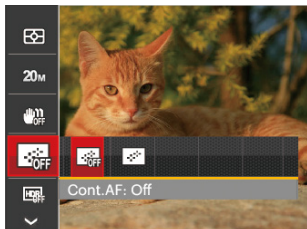

There are 2 options:

- Off
- On

HDR (High Dynamic Range)

Use this setting to control wide dynamic image range when taking static pictures. Photos with extreme contrast of bright and dark areas will still maintain distinguishable detail and depth. (Use of tripod is recommended)



There are 2 options:

- Off
- On





In the scenario with high light contrast (too dark or too light), this function can be used to shoot satisfactory photos.

Face Beautifier

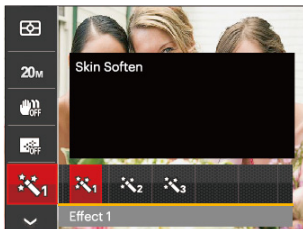
Select the effect for Face Beautifier Mode.



Face Beautifier Mode has 3 effects:

-  Effect 1: Skin Soften
-  Effect 2: Skin Soften + Eye Brightening
-  Effect 3: Skin Soften + Eye Brightening + Eye Enlargement

Scene

Select a scene mode under SCN Mode.

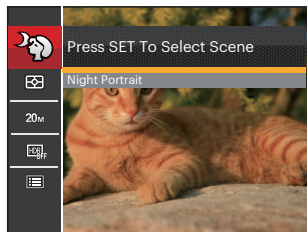

• Shooting Menu in the Shooting Mode (O: Available X: Unavailable)







Options	Shooting Modes					
		P	S	A	M	
	O	O	O	O	O	O
20M	O	O	O	O	O	O
 OFF	O	O	O	O	O	O
 OFF	O	O	O	O	O	O
 OFF	O	O	O	O	O	X
 1	X	X	X	X	X	O

Photo Shooting Setting Menu

Mode: **PSAM** + **SCN**

1. Press the button in Photo Shooting Mode and press the up/down buttons to select .

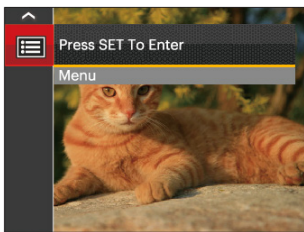

2. Press the button to enter the menu.
3. Press the up/down arrow buttons to select , and press the button or right arrow button to enter the menu.
4. Press the up/down arrow buttons to pick the item to be selected and press the button or right arrow button to enter the menu.

5. Press the up/down arrow buttons to select an option and press the button to confirm.

Quality

The Quality Setting can be used to adjust the image compression ratio.

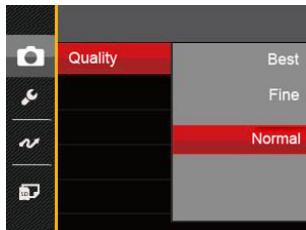

There are three options for picture quality:

- Best (20M Average File Size: 5.0MB)
- Fine (20M Average File Size: 3.0MB)
- Normal (20M Average File Size: 2.6MB)

AF Assist Beam (Auto-Focus Assist Beam)

In a darker environment, the AF assist beam setting can be turned on for better focus.

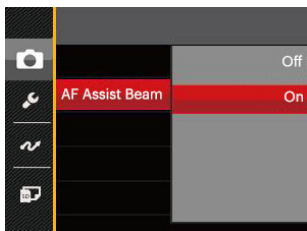

Digital Zoom

Turn the Digital Zoom on or off.

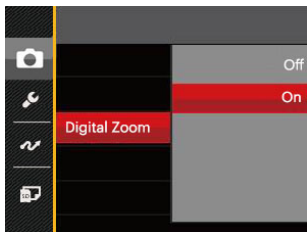

Date Imprint

Include a Date/Time stamp on the photo image.

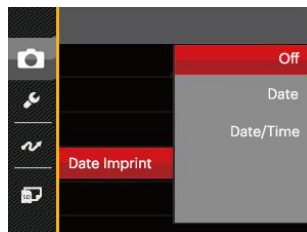

- Off
- Date
- Date / Time

Quick Review

This option allows quick review of the photos immediately after they are taken. Each photo is displayed on the LCD screen for the selected time.

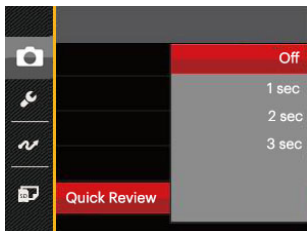

There are 4 options:

- Off
- 1 sec
- 2 sec
- 3 sec

Custom Settings

Custom Settings stores the current photo shooting mode and its parameters. The stored mode and parameters are directly invoked in Custom Settings mode.

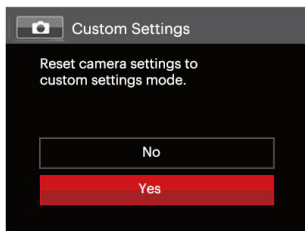

There are 2 options:

- No
- Yes

Face Detection

Detects and focuses on faces to make all faces as clear as possible in Photo Mode.

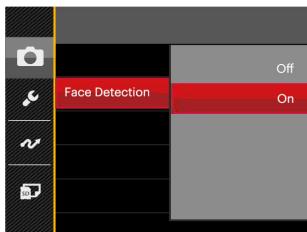



There are 2 options:

- Off
- On

Movie Menu

Mode: 

1. Turn the Mode dial, select the  mode and press the  button to enter the Movie Menu.

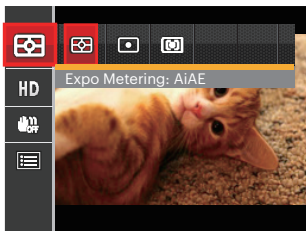

2. Press the up/down arrow buttons to select the Movie Menu to be set.
3. Press the left/right arrow buttons to select the Movie Menu to be set and press the  button to confirm.

Expo Metering (Exposure Metering)

Use this setting to select the "target" size of the camera's field of view to be metered.



There are 3 options:

- AiAE (Artificial Intelligence AE): Automatically selects the central and peripheral metering, to calculate the reasonable value of metering by weighting.
- Spot: Metering targets a small area in the center of the camera's field of view.
- Center: Metering targets a slightly larger area in the center of the camera's field of view.

Video Quality

Set the image resolution used during video recording.

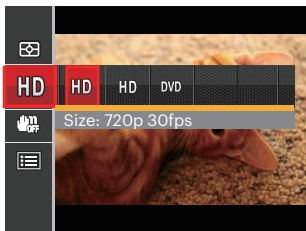

The speed requirements for reading and writing high resolution image pixel images to a memory card are as follows:

No.	Image Pixels	Frames	Recom mendation	Approximate Recording Time (4GB)
1	1280 x 720 *	30	Class 6	57 Minutes
2	1280 x 720	15	Class 4	63 Minutes
3	640 x 480	30	Class 4	72 Minutes

 * The longest recording time is 29 minutes at one time.

 When recording in higher pixel resolutions for extended periods of time, this can cause the camera to generate heat. This is not a camera malfunction.

OIS (Optical Image Stabilization)

This mode can help reduce photo blur caused by unintentional shaking, low light or slow shutter speed.

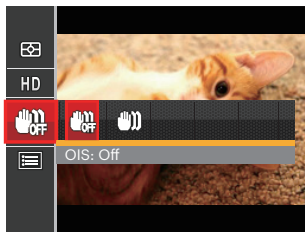





 Use the Image Stabilization Mode in darker environments.





 Shooting in a windy or unstable environment (such as a moving vehicle) may cause blurry images.

Movie Setting Menu

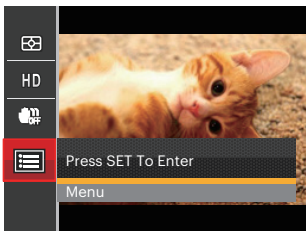
Mode: 

1. Turn the Mode Dial and select  to enter the video recording screen.
2. Press the  button and press the up/down arrow buttons to select . Press the  button to enter the menu.



3. Press the up/down arrow buttons to select  and press the  button or right arrow button to enter the menu.
4. Select the items to be set and press the  button or the right arrow button to enter the menu.
5. Press the up/down arrow buttons to select an option and press the  button to confirm.

Digital Zoom

Turn the Digital Zoom on or off.

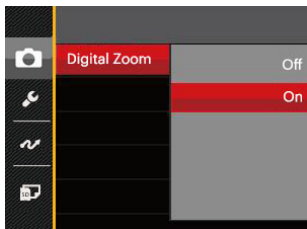



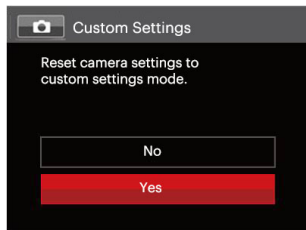

Custom Settings

Custom settings stores the current movie shooting mode and its parameters. The stored mode and parameters are automatically used in Custom Settings Mode.



Playback Menu

Mode: 

1. Press the  button to display the playback screen and press  button to enter the menu.
2. Press the up/down arrow buttons to select the playback desired and press  button to enter.
3. Press the left/right arrow buttons to select an option and press the  button to confirm.

Photo

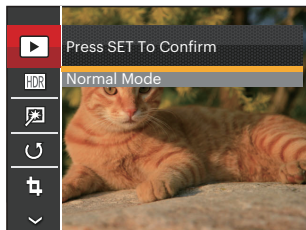

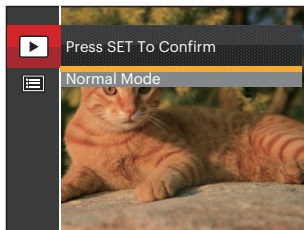

Video



Refer to the following pages 69 to 72 for more details about each setting.

Playback

1. Press the  button, select the  settings, and press the  button to display the settings screen.
2. Press the left/right buttons to select from the following 2 functions:

 Normal Mode: Display all images.

 Date Mode: Arranged by date.

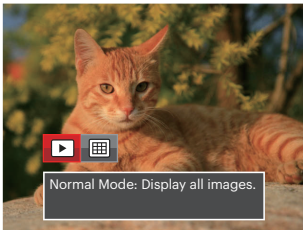



3. Press the  button to confirm the setting.



The Date Folder is displayed in date order based on camera's Date/Time Settings.

HDR (High Dynamic Range)

With the HDR function, pictures that are overexposed may be corrected to optimize the highlights and lowlights captured to more accurately represent the actual scene.

1. In Playback Mode, press the left /right arrow buttons to select the photos to be edited.
2. Press the  button, select the  settings, and press the  button to display the settings screen.
3. Press the left/right buttons to select whether HDR is used.

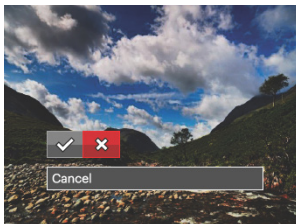



✓ : HDR

✗ : Cancel

4. After using the HDR function, the image will be saved as a new file and the original file is still stored in the memory.

Touch-Up

1. In Playback Mode, press the left /right arrow buttons to select the photos to be edited.
2. Press the  button, select the  settings, and press the  button to display the settings screen.
3. Press the left/right buttons to select Touch-up or [Cancel] to return to the playback Screen.





 : Red-Eye Reduction

 : Skin Soften

 : Eye Brightening

 : Eye Enlargement

 : Cancel



4. Press the  button to confirm the setting.





The Touch-Up referred to is the individual use of three effects. Beauty Mode allows you to select one, two or all three of the effects combined.

Rotate

You can use this setting to change the orientation of the picture.

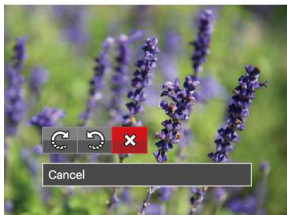
1. In Playback Mode, press the left /right arrow button to select the photos to be edited.
2. Press the  button, select the  settings, and press the  button to display the settings screen.
3. Press the left/right buttons to select the rotation direction or [Cancel] to return to the playback Screen.



 : Turn Right

 : Turn Left

 : Cancel

4. Press the **SET** button to confirm the setting.





Videos and panoramic pictures cannot be rotated.



The rotated picture file will replace the original photo.

Resize

This setting allows you to resize a picture to a particular resolution and saves it as a new picture.

1. In Playback Mode, press the left /right arrow buttons to select the photos to be edited.
2. Press the  button, select the  settings and press the **SET** button to display the settings screen.
3. Press the left/right arrow buttons to select [1024 X 768] or [640 X 480] or select [Cancel] to return to the playback Screen.



4. Press the **SET** button to confirm the setting.

"i" Button Playback Function

This setting allows you to change the picture color effect. The file is saved as a new photo and stored in memory together with the original photo.

1. In Playback Mode, press the left /right arrow buttons to select the photos to be edited.
2. Press the **(i)** button to select the Image Color Setting Menu.
3. Press the left/right buttons to select the corresponding menu or [Cancel] to return to the playback Screen.

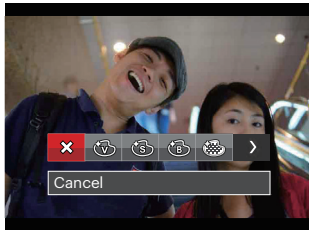





4. Press the **(SET)** button to confirm the setting.

There are 8 options:



- Cancel
- Vivid
- Sepia
- Black and White
- Grainy
- Vignetting
- Salon
- Dreamy

Playback Setting Menu

Mode: 

1. Press the  button to show the playback screen, press the  button, and press the up/down buttons to select .
2. Press the  button to enter the menu.



3. Press the up/down arrow buttons to select , and press the  button or right arrow button to enter the menu.
4. Press the up/down arrow buttons to select the item to be set and press the  button or right arrow button to enter the menu.

5. Press the up/down arrow buttons to select an option and press the  button to confirm.

Refer to the following pages 75 to 77 for more details about each setting.

Protect

To prevent any pictures or videos from being accidentally erased, use this setting to lock one or all of the files.



To lock or unlock the photo and video files:

1. Press the up/down arrow buttons to select [Protect] and press the **SET** button or right arrow button to enter the sub-menu.
2. Press the up/down arrow buttons to select the sub-menu and press the **SET** button or right arrow button to show the settings screen.

There are 4 sub menus available:

- One: Lock the selected photo or video if they are unprotected; unlock the selected photo or video if they are protected.
 - Date Folder: Protect all photos in the Date Folder.
 - All: Lock all photos or videos.
 - Reset: Cancel all locked photos or videos.
3. Press the up/down arrow buttons to select an option and press the **SET** button to confirm.

Delete

You can delete one or all photo/video files.

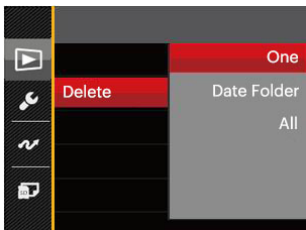





To delete photo or video files:

1. Press the up/down arrow buttons to select [Delete] and press the **(SET)** button or right arrow button to enter the submenu.
2. Press the up/down arrow buttons to select the submenu and press the **(SET)** button or right arrow button to show the settings screen.

There are 3 sub menus available:

- One: Delete one photo or video.
 - Date Folder: Delete all photos in the Date Folder.
 - All: Delete all photos or videos.
3. Press the up/down arrow buttons to select an option and press the **(SET)** button to confirm.

-  The “” indicator means a file is protected. File protection must be removed before a file can be deleted.
-  Deleting files will cause DPOF (Digital Print Order Format) settings to be reset.
-  When a single photo is protected in the date folder, the protected photo will be kept and other photos will be deleted.
-  Deleted files will be permanently deleted and will not be able to be recovered or restored.

DPOF (Digital Print Order Format)

The DPOF feature allows you to compile and select a group of pictures that you would like to print and will save your selection on the memory card so that you can use the SD memory card to print without having to individually specify the photos you want to print.

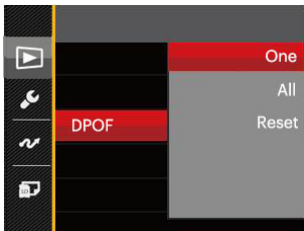

The printer that supports DPOF is needed for photo printing.

Trim

The Trim Setting allows you to crop photos and save them as new pictures.

1. Press the up/down arrow buttons to select [Trim] and press the **SET** button or right arrow button to enter the menu.
2. Select [Yes] to confirm trim. Select a section of the photo to be trimmed using the Zoom Lever and arrow buttons to trim a photo.

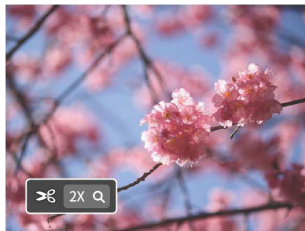







3. Press the **SET** button and the [Save change?] prompt appears. Select to change and save the picture. Select to cancel changes and return to the trim prompt screen.



The image cannot be clipped/trimmed again once it has been clipped to 640 X 480.

Setup Menu

Mode :  **PSAM**   **SCN**  

1. Press the  button in any mode and press the up/down buttons to select .
2. Press the  button to enter the menu.
3. Press the up/down arrow buttons to select  and press the  button or right arrow button to enter the menu.
4. Press the up/down arrow buttons to select the item to be set and press the  button or right arrow button to enter the menu.
5. Press the up/down arrow buttons to select an option and press the  button to confirm.

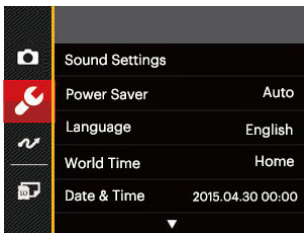

Refer to the following pages 79 to 80 for more details about each setting.

Sound Settings

To change this setting:

1. Select [Sound Settings] in the basic settings menu. Press the **SET** button or right arrow button to enter the menu.
2. Press the left/right arrow buttons to select an option.

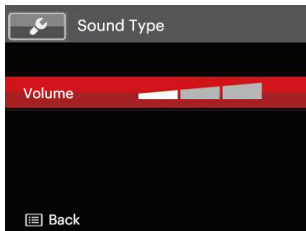

3. Press the **SET** button to confirm.

Power Saver

This setting allows you to save power and get the maximum possible running time for your camera's batteries. Follow the steps below to turn the LCD screen and camera off automatically after a consecutive period of inactivity.

1. Select [Power Saver] in the basic settings menu. Press the **SET** button or right arrow button to enter the menu.
2. Press the up/down arrow buttons to select an option.

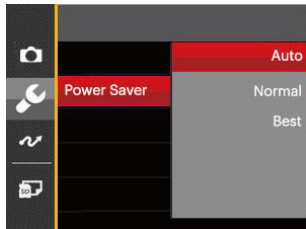

3. Press the **SET** button to confirm.



Power Saver	LCD Power Off Time	Turn Off Time
Auto	3 Min	5 Min
Normal	1 Min	3 Min
Best	30 S	1 Min

Language

Refer to the “Resetting your language” section on page 20.

World Time

The Zone setting is a useful function for your overseas trips. This feature enables you to display the local time on the LCD screen while you are abroad.

1. Select [World Time] in the basic settings menu. The World Time screen appears.
2. Press the up/down to select the departure place () and destination () fields.
3. Press the left/right arrow buttons to select a city located in the same time zone as that of the field. Press the  button to confirm settings.



Date/Time

Refer to the “Resetting Date/Time” section on page 21.

LCD Brightness

Use this setting to adjust the brightness of your LCD screen.

1. Select [LCD Brightness] in the basic settings menu. Press the  button or right arrow button to enter the menu.
2. Press the up/down arrow buttons to select an option.

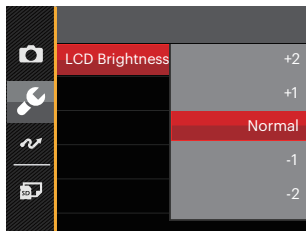







3. Press the  button to confirm.

File Settings

Format Memory

Please Note: formatting enables you to delete all contents on a memory card and camera's built-in memory, including protected photo and movie files.

To use this setting:

1. Press the  button, press the up/down arrow buttons to select  and press the  button to enter the menu.
2. Press the up/down arrow buttons to select  and press the  button or right arrow button to enter the menu.
3. Press the up/down arrow buttons to select [Format] and press the  button or right arrow button to enter the menu.
4. Press the up/down arrow buttons to select [Yes] or [No] and press the  button to confirm.
5. If you select [Yes] the camera formats its memory.





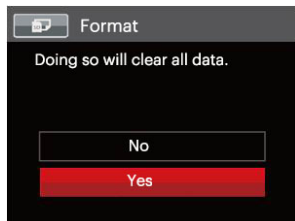



If there is no memory card in the camera, the built-in memory will be formatted; if there is a memory card installed, only the memory card will be formatted.



Copy to Card

Use this setting to copy the files stored in the internal memory to an SD memory card.







1. Press the  button, press the up/down arrow buttons to select  and press the  button to enter the menu.
2. Press the up/down arrow buttons to select  and press the  button or right arrow button to enter the menu.
3. Press the up/down arrow buttons to select [Copy to Card] and press the  button or right arrow button to enter the menu.
4. Press the up/down arrow buttons to select [Yes] or [No] and press the  button to confirm.



If there is no card available in the camera, this function will not be displayed.

File Numbering







After you take a picture or video clip, the camera will save it with a sequential number. You can use this to reset the file numbering to 1.

1. Press the  button, press the up/down arrow buttons to select  and press the  button to enter the menu.
2. Press the up/down arrow buttons to select  and press the  button or right arrow button to enter the menu.
3. Press the up/down arrow buttons to select [File Numbering] and press the  button or right arrow button to enter the menu.
4. Press the up/down arrow buttons to select [Yes] or [No] and press the  button to confirm.



Reset





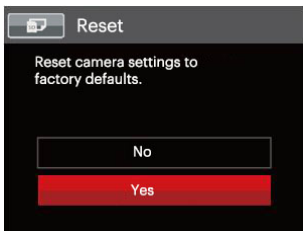

Use this setting to restore the camera to its original default settings.

1. Press the  button, press the up/down arrow buttons to select  and press the  button to enter the menu.
2. Press the up/down arrow buttons to select  and press the  button or right arrow button to enter the menu.
3. Press the up/down arrow buttons to select [Reset] and press the  button or right arrow button to enter the menu.
4. Press the up/down arrow buttons to select [Yes] or [No] and press the  button to confirm.



Firmware (FW) Version

Use this setting to view the current camera firmware version.

1. Press the  button, press the up/down arrow buttons to select  and press the  button to enter the menu.
2. Press the up/down arrow buttons to select  and press the  button or right arrow button to enter the menu.
3. Press the up/down arrow buttons to select [FW Version] and press the  button or right arrow button to enter the menu.
4. When there is a new firmware version in the SD card, select [Yes] to update.









CONNECTIONS

Connecting to a Computer

You can use a Micro USB cable to connect the camera and copy (transmit) photos to a computer, printer or other device.

Setting the USB Mode

The camera's USB port can be used to connect to either a computer or a printer. The following steps will allow you to ensure that the camera is correctly configured to connect with a computer.

1. Press the  button, press the up/down arrow buttons to select  and press the  button to enter the menu.
2. Press the up/down arrow buttons to select  and press the  button or right arrow button to enter the menu.
3. Press the up/down arrow buttons to select [USB] and press the  button or right arrow button to enter the menu.
4. Press the up/down arrow buttons to select [PC] and press the  button to confirm.

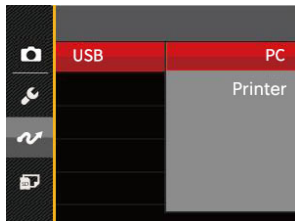

Transferring Files to Your Computer

The computer will automatically detect the camera as a removable drive. Double-click the My Computer icon on the desktop to locate the removable drive and to copy folders and files in the drive to a directory on your PC as you would copy any typical folder or file.





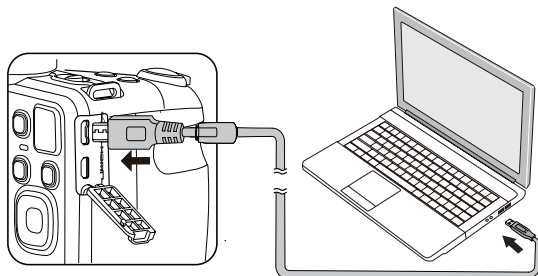

Follow the steps below to connect the camera to a computer:

1. Make sure the computer is turned on.
2. Connect one end of the supplied Micro USB cable to the USB OUT port on your camera.
3. Connect the other end of the cable to an available USB port on your computer.
4. After the transmission is complete, disconnect the micro USB cable according to your computer manufacturer's instructions specifying how to safely remove USB devices.



Video System

You can use the AV cable (which should be purchased separately) to connect the camera and the television for setting up the video output. Connect one end of the AV cable to USB/AV port of the camera and connect the other end to AV-OUT port of the television. To adjust the format of the video output system according to your requirements:

1. Press the  button, press the up/down arrow buttons to select  and press the  button to enter the menu.
2. Press the up/down arrow buttons to select  and press the  button or right arrow button to enter the menu.
3. Press the up/down arrow buttons to select [TV-System] and press the  button or right arrow button to enter the menu.
4. Press the up/down arrow buttons to select [NTSC] or [PAL] and press the  button to confirm.

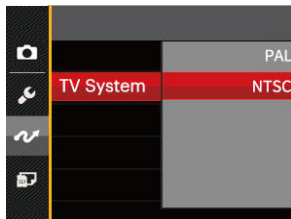







NTSC: English, Chinese (Traditional), Japanese, Korean, Vietnamese

PAL: German, Spanish, Italian, Chinese (Simplified), Portuguese, Swedish, Danish, Finnish, Indonesia, Norwegian, Dutch, Turkish, Polish, Thai, Croatian, Czech, Arabic, Hindi, French, Russian, Greek, Hungarian

Set Eye-Fi Card Connection Mode

This camera supports wireless connection for Eye-Fi cards. Enable the Eye-Fi connection by following the steps below:

1. Press the  button, press the up/down arrow buttons to select  and press the  button to enter the menu.
2. Press the up/down arrow buttons to select  and press the  button or right arrow button to enter the menu.
3. Press the up/down arrow buttons to select [Eye-Fi] and press the  button or right arrow button to enter the menu.
4. Press the up/down arrow buttons to select [On] or [Off] and press the  button to confirm.

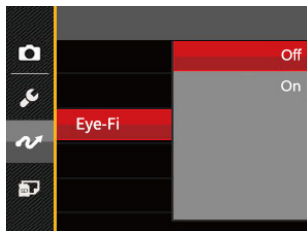

If the Eye-Fi card is not available in the camera, this feature is not displayed.

Supported HDMI Connections

HDMI (High Definition Multimedia Interface), is a fully digital audio/video transmission interface, through which uncompressed audio and video signals are transmitted.

Direct transmission of digital video signals to your TV reduces conversion loss and improves image quality.

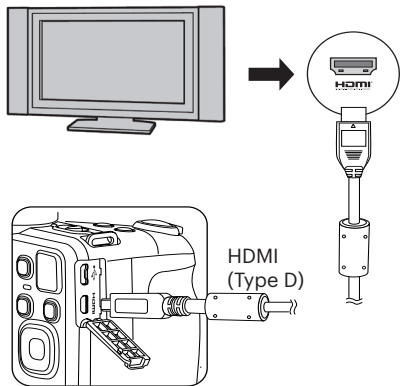

Connecting HDMI-Ready TV

1. Use a cable with a high resolution output terminal (which should be purchased separately) to connect the camera to the television which meets HDMI standards.
2. The camera will be automatically detected by the TV.
3. After connecting via HDMI, the camera enters Playback Mode.



Make sure the camera and the TV are both turned on before connecting.



Refer to your TV instruction manual for information on what resolution sizes it will support. The resolution and output formats that are not supported will be grayed out on the camera's LCD screen.







Connecting to a PictBridge Compatible Printer

PictBridge technology allows printing of photos saved on the memory card by a PictBridge compatible printer.



To find out if a printer is PictBridge compatible, simply look for the PictBridge logo on the packaging or check the owner's manual for specifications. With the PictBridge function on your camera, you can print captured photos directly to a PictBridge compatible printer using the micro USB cable, without the need for a PC.

Setting the USB Mode

The camera's USB port can be set to connect with either a PC or a Printer, the following steps will ensure that the camera is correctly configured to connect with a Printer.

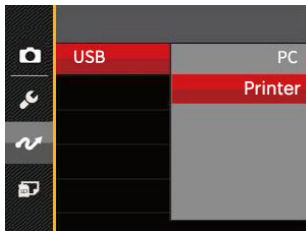
1. Press the  button and press the up/down arrow buttons to select . Press the  button to enter the menu.
2. Press the up/down arrow buttons to select  and press the  button or right arrow button to enter the menu.
3. Press the up/down arrow buttons to select [USB] and press the  button or right arrow button to enter the menu.
4. Press the up/down arrow buttons to select [Printer] and press the  button to confirm.



-  After the camera is reset, it will switch to PC mode automatically from USB mode.
-  See “Using the PictBridge Menu” section on page 91.

Connecting to Your Printer

1. Make sure the printer is turned on.
2. Connect one end of the supplied Micro USB cable to the USB port on your camera.
3. Connect the other end of the cable to the USB port on the printer.

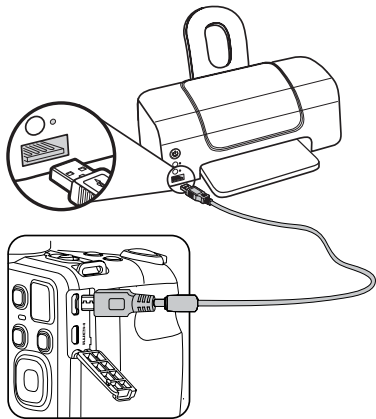

If the camera is not connected to a PictBridge compatible printer, the following error message will appear on the LCD screen.

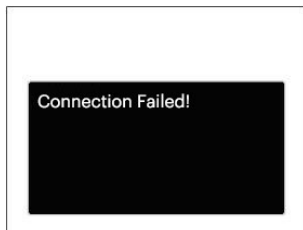

-  The error message above will also appear if the USB mode is set incorrectly, in which case you should disconnect the Micro USB cable, check the USB mode settings, ensure that the Printer is turned on, and then try connecting the Micro USB cable again.

Using the PictBridge Menu

After setting the USB mode to Printer, the PictBridge Menu will appear.



Press the up/down arrow buttons to select a menu item and press the **SET** button or right arrow button to enter the item.

Refer to the following sections for more detailed information on each setting.

Print (with Date)

If you have set the date and time on your camera, the date and time will be recorded and saved with each photo you take.

1. In the PictBridge menu, select [Print (with Date)] and the screen as shown below appears.

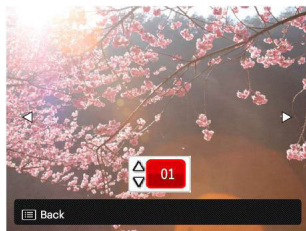

2. Press the left/right arrow buttons to select a photo to be printed.

3. Press the up/down arrow buttons to select the number of copies for the currently displayed photo.
4. Press the **SET** button and the following screen will appear.

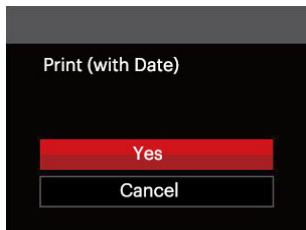

5. Select [Yes] and press the **SET** button to confirm; select [Cancel] to cancel printing.

Print (without Date)

Use this setting to print the photos without dates on them.

1. In the PictBridge menu, select [Print (without Date)] and the screen as shown below appears.

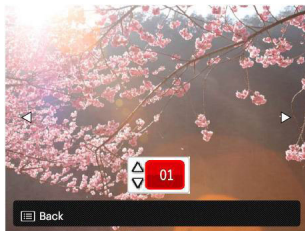

2. Press the left/right arrow buttons to select a photo to be printed.
3. Press the up/down arrow buttons to select the number of copies for the currently displayed photo.
4. Press the **SET** button and the following screen will appear.

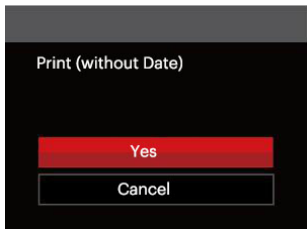

5. Select [Yes] and press the **SET** button to confirm; select [Cancel] to cancel printing.

Print Index

You can print all photos in the camera via this function.

1. In the PictBridge menu, select [Print Index] and the screen as shown below appears.

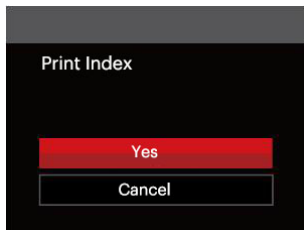

2. Select [Yes] and press the **SET** button to confirm; select [Cancel] to cancel printing.

Print DPOF Images

To use DPOF printing, you must select your photos for printing using the DPOF settings before hand. See "DPOF" section on page 77.

1. In the PictBridge menu, select [Print DPOF Images] and the screen as shown below appears.

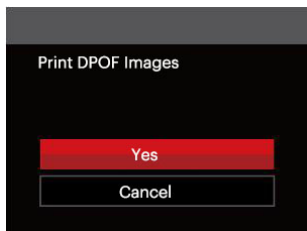

2. Select [Yes] and press the **(SET)** button to confirm; select [Cancel] to cancel printing.

Exit

Select [Exit] to exit the PictBridge menu. At this time, the message [Remove USB cable!] will appear on the screen.



Disconnect the Micro USB cable from the camera and printer.

APPENDICES

Specifications



Design and specifications are subject to change without notice.

Effective Image Sensor Pixels		20.16 Megapixels
Total Image Sensor Pixels		20.48 Megapixels [1/2.3"CCD]
Lens	Focal Length	4.3mm (Wide) - 180.6mm (Tele)
	35mm Film Equivalent	24mm (Wide) - 1008mm (Tele)
	F Number	F3.0 (Wide) - F6.8 (Tele)
	Lens Construction	11 groups 15 elements
	Optical Zoom	42x
	Focusing Range	Normal: (Wide) 50cm ~ ∞, (Tele) 200cm ~ ∞; Macro: 1.6cm ~ ∞ (Wide Only)
Anti-Handshake		Optical Image Stabilization
Digital Zoom		4x Digital Zoom (Combined Zoom: 168x)

Number of Recording Pixels	Still Image	(4:3) 20MP: 5152 × 3864 10MP: 3648 × 2736 5MP: 2592 × 1944 3MP: 2048 × 1536 0.3MP: 640 × 480	(3:2) 17MP: 5152 × 3432	(16:9) 15MP: 5152 × 2896 2MP: 1920 × 1080
	Movie	1280 × 720 (30fps), 1280 × 720 (15fps), 640 × 480 (30fps)		
Image Compression		Best, Fine, Normal		
DCF, DPOF (Ver1.1) Support		Yes		
File Format	Still Image	Exif 2.3 (JPEG)		
	Movie	MOV [Image: H.264; Audio: Linear PCM (Monaural)]		
Shooting Modes		Auto Mode, Program AE, Shutter Priority, Aperture priority, Manual Mode, Face Beautifier, Panorama Mode, Scene Mode [Pet Mode, Sunset, Fireworks, Sport, Night Portrait, Landscape, Portrait, Snow, Children, Party, Night Landscape, Auto Scene], Movie Mode, Custom Settings		
Detection Features		Face, Smile, Blink, Cat, Dog		
Photo Touch-up		Red-Eye Reduction, Skin Soften, Eye Brightening, Eye Enlargement		

HDR	Yes
Video Panorama	Up to 180° (Horizontal)
LCD Display	3.0 inch (460k Pixels)
ISO Sensitivity	Auto, ISO80/100/200/400/800/1600/3200(4M)
AF Method	Single AF, Multi-AF (TTL 9-point), Object Tracking, Face-Detection
Exposure Metering Method	Artificial Intelligence AE (AiAE), Center-Weighted Average, Spot (Fixed to Center of Frame), Face AE
Exposure Control Method	Program AE (AE-Lock Available), Shutter Prior AE, Aperture Prior AE
Exposure Compensation	± 2 EV in 1/3 Step Increments
Shutter Speed	1/2000 ~ 30 Seconds
Continuous Shooting	Yes
Playback Modes	Single, Index (9/16 Thumbnails), Slide Show, Date, Zoom (Approx. ×2 ~ ×8)
White Balance Control	AWB, Daylight, Cloudy, Fluorescent, Fluorescent CWF, Incandescent, Manual WB, Color Temp. (1900K ~ 10000K)

Flash	Flash Method	Pop-up (Manual)
	Flash Modes	Force Off, Flash Auto, Force Flash, Slow Sync., Slow Sync. + Red-Eye, Red-Eye Reduction
	Shooting Range	(Wide) Approx. 0.5m ~ 7.5m (ISO 800) (Tele) Approx. 1.2m ~ 3.7m (ISO 800)
Recording Media		Internal Memory: Approx. 8MB
		SD/SDHC Card (Up to 32GB Support) [MMC Card not supported]
Multi-Language Support (27 Languages)		English, Chinese (Simplified and Traditional), Japanese, Korean, French, Spanish, Portuguese, Thai, Indonesia, Vietnamese, Italian, German, Dutch, Russian, Polish, Swedish, Danish, Finnish, Norwegian, Greek, Turkish, Hungarian, Croatian, Czech, Arabic, Hindi
Jacks		AV-OUT/USB 2.0 (Micro 5 pin USB), HDMI (Type D)
Eye-Fi Support		Yes
Power		Rechargeable Li-ion Battery LB-060, 3.7V 1100mAh, In-Camera Charging
Shooting Capability (Battery Performance)		Approx. 200 Shots (Based on CIPA Standards)
Operation Environment		Temperature: 0 ~ 40°C, Humidity: 0 ~ 90%
Dimensions (W × H × D)		Approx. 112.7 × 81.6 × 84.4mm (Based on CIPA Standards)
Mass		Approx. 444 g (Body only)

Prompts and Warning Messages

Message	Description	Action
Warning! Battery exhausted.	The camera batteries are depleted. It is a warning indicating that the camera is going to shut off.	Replace with new batteries. The camera will shut down in 2 seconds.
Lens obstruction, Re-start Camera.	The lens is jammed or some foreign object is preventing the lens from functioning properly.	Turn the camera off and restart it to reset the lens.
Battery temperature is too high.	The battery temperature reaches 58°C.	Let the battery cool before attempting to use the camera again. This message will disappear after 2 seconds.
Built-in memory error!	An error has occurred in the built-in memory.	Try shutting down the camera and turning it on again. This message will disappear after 2 seconds.
Improper alignment. Please try again.	The offset is too big for panorama shooting.	Retry taking the panoramic picture. This message will disappear after 2 seconds.
Warning! Do not turn off your camera during update!	This message appears during the firmware update process.	The message disappears after the camera update and restart.

Message	Description	Action
Remove USB Cable!	Indicates that you can disconnect the USB cable.	The message disappears after you disconnect the USB cable.
Connection Failed!	Failure to connect to your PC, printer, TV (with HDMI).	Remove USB cable and retry connection
Write Protect !	The SD card is locked.	Remove SD card and switch the lever on the side of card to UNLOCK. This message will disappear after 2 seconds.
Card Full !	Indicates that the SD card is full.	Replace SD card with another that has available memory. This message will disappear after 2 seconds.
Memory Full !	Indicates that the camera memory is full.	Erase Files or replace memory card in order to take more photos or videos.
Card Error !	The memory card can't be identified after being formatted.	Normal display.

Message	Description	Action
Card is not formatted.	When an error occurs with the memory card, the message "Not Formatted" will appear.	Format the memory card. WARNING: Formatting the SD card will erase all data on the card. Copy the data from the memory card to another storage device, such as a computer. Otherwise, all data will be erased after the format. This message will disappear after 2 seconds.
Slow access	When an SD card lower than Class 4 is used to record a HD movie, the writing speed will be slower and recording will not continue.	Replace SD card with a higher Class over 4. This message will disappear after 2 seconds.
Cannot write to SD card.	The photo shooting or video recording has been interrupted so recording cannot continue.	Turn off the camera. Then unload and reload the SD card and turn on the camera to retry. Also check if SD card is full or in a locked position.
No Red-Eye Detected!	Red eyes have not been detected in the image.	This message will disappear after 2 seconds.
This image cannot be edited.	The file format does not support editing or the edited file cannot be edited again.	This message will disappear after 2 seconds.

Message	Description	Action
Exceeded maximum folder number.	Prompt message when the archives or file folders in memory card have reached the maximum (9999 for archives, 999 for file folder).	Copy the data to your PC, and format the memory card using the camera.
Too many pictures for quick processing.	During the playback by date, the images exceed specifications so that it is not possible to play by date.	The message disappears after 2 seconds and the camera returns to normal playback mode.
Unable to recognize files.	The format of the file to be viewed is not supported or the file is corrupted so it cannot be properly read.	This image message disappears only after the file is deleted.
No Picture!	When you press the play button, no image files exist in the camera or memory card.	This message disappears after 2 seconds and returns to the photo shooting screen.
Protected! Undeletable!	The file is protected. The message appears when you go into delete mode.	Remove SD card and switch the lever on the side of card to UNLOCK. Place card back into the camera and try again. This message will disappear after 2 seconds.

Troubleshooting

Problem	Possible causes	Solution
Camera does not turn on	<ul style="list-style-type: none">■ The battery has been depleted.■ The battery is not inserted correctly.	<ul style="list-style-type: none">■ Replace the battery.■ Correctly reinstall the battery.
Camera turns off suddenly during operation	<ul style="list-style-type: none">■ The battery has been depleted.	<ul style="list-style-type: none">■ Replace the battery.
The picture is blurry	<ul style="list-style-type: none">■ Camera movement while taking a picture.	<ul style="list-style-type: none">■ Turn on OIS Feature.■ Please use tripod for high magnification (above 15X) optical zoom.
Images and video files cannot be saved	<ul style="list-style-type: none">■ The SD memory card is full.■ The memory card is locked.	<ul style="list-style-type: none">■ Use another memory card or delete unnecessary files.■ Unlock the memory card.
Images will not print from the connected printer	<ul style="list-style-type: none">■ The camera is not connected to the printer correctly.■ The printer is not PictBridge compatible.■ The printer is out of paper or ink.■ The printer paper is jammed.	<ul style="list-style-type: none">■ Check the connection between the camera and printer.■ Use a PictBridge compatible printer.■ Load paper into the printer or replace the ink cartridge in the printer.■ Remove the jammed paper.

Problem	Possible Causes	Solution
Saving data to memory card is slow	<ul style="list-style-type: none"> ■ Using a memory card below Class 4 may result in slower recording times. 	<ul style="list-style-type: none"> ■ Use an memory card with write Class 4 or higher to improve performance.
Cannot write to the memory card	<ul style="list-style-type: none"> ■ The SD memory card has been locked. 	<ul style="list-style-type: none"> ■ Release the write lock of the memory card or replace with another card.
Too many movies to process	<ul style="list-style-type: none"> ■ The number of pictures or folders in the SD memory card exceed the specifications, so the playback of data folder can not be displayed. 	<ul style="list-style-type: none"> ■ Delete unwanted files.
The flash  flashes on the LCD screen.	<ul style="list-style-type: none"> ■ Current shooting environment requires flash. 	<ul style="list-style-type: none"> ■ Turn on flash.

Memory Card Compatibility

• Cards compatible with this camera (√ : Compatible X: Not Compatible)

	micro SD	micro SDHC	micro SDXC	Conversion adapter to SD card	SD	SDHC	SDXC
Format	FAT12, 16	FAT32	exFAT	-	FAT12, 16	FAT32	exFAT
Capacity	Up to 2GB	4-32GB	64GB-2TB	-	Up to 2GB	4-32GB	64GB-2TB
Compatibility	X	X	X	√	√	√	X

It indicates that the writing speed class will be displayed on the memory card.

Use a memory card with the appropriate writing speed for the video recording mode to be recorded. (O: Recommended X: Not recommended)

	Speed Class	UHS Speed Class	Video Speed Class	Video Recording			
				4K	FHD	HD	VGA
90MB/sec			V90	O	O	O	O
60MB/sec		UHS-III	V60	O	O	O	O
30MB/sec		UHS-I	V30	O	O	O	O
10MB/sec	Class 10		V10	O	O	O	O
6MB/sec	Class 6		V6	X	O	O	O
4MB/sec	Class 4			X	X	X	O
2MB/sec	Class 2			X	X	X	O

© 2023 JK Imaging Ltd. All Rights Reserved.

The Kodak trademark, logo and trade dress are used under license from Eastman Kodak Company.

All other logos, products or company names that are referred to in this document are trade names, trademarks or registered trademarks of their respective owners and holders. The owners and holders are not affiliated with JK Imaging Ltd., our products or our website.

JK Imaging Ltd., 17239 So. Main Street, Gardena, CA 90248 USA

kodakpixpro.com

Made in Myanmar (Burma)

