

# Kodak

# PIXPRO FZ151

Digital Camera

*User Manual*



# BEFORE YOU START

## Declaration of Conformity

Responsible Party: JK Imaging Ltd.

Address: JK Imaging Ltd., 17239 So. Main Street,  
Gardena, CA 90248 USA

JK Imaging Europe, 71 Clarendon Road,  
Watford, WD17 1DS, UK

Company website: <http://kodakpixpro.com>

## For Customers in the U.S.A.

### Tested to Comply with FCC Standards FOR HOME OR OFFICE USE

This device complies with part 15 of the FCC Rules.

Operation is subject to the following two conditions:

(1) This device may not cause harmful interference,  
and (2) this device must accept any interference  
received, including interference that may cause  
undesired operation.

## For Customers in Europe

 "CE" mark indicates that this product complies with the European requirements for safety, health, environment and customer protection. "CE" marked cameras are intended for sales in Europe.



This symbol [crossed-out wheel bin WEEE Annex IV] indicates separate collection of electrical waste and electronic equipment in the European countries. Please do not throw the equipment into domestic refuse. Please use the return and collection systems available in your country for proper, safe disposal of this product.

## About this Manual

Thank you for purchasing this KODAK PIXPRO Digital Camera. Please read this manual carefully and keep it in a safe place for future reference.

- JK Imaging Ltd. reserves all rights of this document. No part of this published manual may be reproduced, transmitted, transcribed, stored in a retrieval system or translated into any language or computer language, in any form, by any means, without the prior written permission of JK Imaging Ltd..
- All trademarks mentioned in this manual are used for identification purposes only and are properties of their respective owners.
- This manual provides you with instructions on how to use your new KODAK PIXPRO Digital Camera. Every effort has been made to ensure that the contents of this manual are accurate, however JK Imaging Ltd. reserves the right to make changes without notice.
- Throughout this manual, the following symbols are used to help you locate information quickly and easily:



Indicates useful information.



Indicates precautions are to be taken while operating the camera.

# SAFETY NOTES

## Safety notes for this camera

- Do not drop the camera or allow it to hit solid objects.
- Do not attempt to disassemble the camera.
- To prevent the camera from being damaged by moisture, do not use or store the camera in very humid environments, such as in rain or near bodies of water.
- Do not use or store the camera in dusty places or on a beach to prevent dust or sand from entering the camera, causing possible damage to it.
- Do not use or store the camera in a hot environment or under direct sunlight.
- Do not use or store the camera near a powerful magnetic field, for example near a magnet or transformer.
- Avoid touching the lens of the camera.
- Do not expose the camera to direct sunlight for a long period time.
- Turn the camera off, remove the battery and the memory card, and dry it within 24 hours if water accidentally comes in contact with the camera.

- When you take the camera from a cold place to a warmer environment, condensation may occur. Please wait for a reasonable period of time before you turn it on.
- When you use the camera, remove the battery if it overheats. Wait until the unit cools down.
- Download your photos and remove the memory card when you are going to store the camera for a long period of time.
- Store the camera in a dry environment and place it on a flat surface when you are going to store the camera for a long period of time.
- Before you remove the battery and memory card, the camera should be turned off.
- When you clean the body of the camera, do not use abrasive, alcohol-based or organic cleaner.
- Use the professional lens wiping cloth and dedicated cleaner to wipe and clean the lens.

## Safety notes for battery

- If the rechargeable Li-ion battery is used for the camera, only charge it with the supplied battery charger.
- If battery fluid leaks inside the camera, contact our customer service department.

- If battery fluid leaks onto your skin, rinse your skin with clean water and seek immediate medical attention.
- Disposal of used batteries should be carried out in accordance with the local (national or regional) regulations.
- To prevent the battery from being damaged, do not drop the battery or allow it to hit solid objects or to be scratched by the objects.
- Do not let the battery come in contact with metal objects (including coins) to avoid short circuiting, discharging, excessive heat, or possible leakage.
- Do not attempt to disassemble the battery.
- Do not expose the battery to water. Always keep the battery contacts dry.
- Do not heat the battery or throw it into a fire to avoid a possible explosion.
- Do not store the battery in a hot environment or in direct sunlight.
- Only use the supplied battery.
- If the rechargeable Li-ion battery in this camera overheats during charging, stop charging immediately and wait until it cools down to resume charging.

- When the camera is stored for a long period of time, remove the battery and keep it in a dry place that is not accessible to the infants and children.
- In a colder environment, the performance of the battery could be noticeably reduced.
- When you install the battery, install it according to the positive and negative markings on the battery compartment. Never force it into the battery compartment.

### **Safety notes for memory card**

- Do not drop the memory card or allow it to hit solid objects to avoid damaging it.
- Do not attempt to disassemble or repair the memory card.
- Do not expose the memory card to water. Always keep it dry.
- Do not remove the memory card when the camera is turned on. Otherwise, the memory card could be damaged.

- Do not directly edit the data on the memory card. Copy the data to your PC before you edit them.
- When the camera is stored for a long period of time, be sure to download your photos and remove the memory card. Store it in a dry environment.
- Format the memory card using the camera before you use it or insert a new one.
- We suggest buying only well-known, name brand memory cards to ensure peak performance.
- Do not modify the name of the files or folders of the memory card using your PC. Modifying the file names may cause the files to not be recognized on the camera or a possible error may occur.
- A photo taken with the camera will be stored in the folder that is automatically generated on the SD card. Do not store photos that are not taken using this camera in these folders as the pictures cannot be recognized during the playback.
- When you insert a memory card, make sure the notch of the card matches the markings on the top of the card slot.

## **Other Safety Notes**

- Do not disconnect the power or turn the camera off during the update process. Doing so may cause incorrect data to be written and the camera may not power on later.
- When using your camera on an airplane, observe the relevant rules specified by the airline.
- Due to the limitations of manufacturing technology, the LCD screen may have a few dead or bright pixels. These pixels do not affect the quality or performance of the camera, photos or video.
- Do not expose the LCD screen to water. In a humid environment, only wipe it with a soft and dry cleaning cloth.
- If the LCD screen is damaged and the liquid crystal comes into contact with your skin, wipe your skin with a dry cloth immediately and rinse it with clean water. If liquid crystal comes into contact with your eyes, wash them with clean water at least for 15 minutes and seek immediate medical attention. If you accidentally swallow liquid crystal, rinse your mouth immediately and seek medical attention.

# CONTENTS

BEFORE YOU START .....	1	MODE OVERVIEW .....	19
SAFETY NOTES .....	2	Display Setting .....	19
CONTENTS .....	5	LCD Screen Display .....	20
GETTING READY .....	9	Overview of the screen icons in photo shooting mode .....	20
Accessories Included .....	9	Overview of the Screen Icons in Movie Mode .....	22
Part Names .....	10	Overview of the Screen Icons in Playback Mode .....	23
Installing Battery and Memory Card .....	13	Using the Mode Selection Button .....	24
Charging Battery .....	15	Manual Mode .....	25
Turning Camera On and Off .....	16	Auto Mode .....	25
Symbol Description .....	16	Portrait Mode .....	26
Set your Language, Date/Time .....	17	Panorama Mode .....	26
Set your Language, Date/Time after the first power-on .....	17	Scene Mode (SCN) .....	28
Resetting your Language .....	17	Auto Scene Mode (ASCN) .....	31
Resetting Date/Time .....	18		

<b>BASIC OPERATION .....</b>	<b>33</b>	<b>USING THE MENUS .....</b>	<b>45</b>
Using the Zoom Function .....	33	Photo Setup Menu .....	45
Macro Mode .....	34	Expo Metering (Exposure Metering) .....	45
Self-timer Setting.....	35	Image Size.....	46
Flash Mode .....	36	OIS.....	46
EV Setting .....	37	Cont. AF.....	47
Exposure Compensation .....	37	Continuous Shot .....	47
ISO.....	38	Focus Setting.....	48
Shutter Adjustment .....	38	White Balance Setting .....	49
Using Quick Recording .....	39	Color Effect .....	49
<b>PLAYBACK.....</b>	<b>40</b>	Photo Shooting Setting Menu .....	51
Viewing Photos and Videos .....	40	Quality.....	51
Thumbnail View.....	41	AF-Assist Beam .....	52
Using Zoom Playback (for still pictures only) ....	42	Digital Zoom.....	52
Slideshow.....	43	Date Imprint .....	53
Photos and Video Deletion.....	44	Quick Review.....	53
		Movie Menu.....	54

Expo Metering (Exposure Metering) .....	54	Sound Settings .....	66
Video Quality .....	55	Power Saver .....	66
OIS.....	55	Language.....	66
Color Effect .....	56	Zone.....	67
Movie Setting Menu .....	57	Date/Time .....	67
Digital Zoom.....	57	File / Software .....	67
Playback Menu.....	58	Format Memory .....	67
HDR .....	58	Copy to Card.....	68
Red-Eye Reduction.....	59	File Numbering .....	68
Rotate .....	59	Reset .....	69
Resize.....	60	FW Version .....	69
Color Effect .....	60		
Playback Setting Menu .....	61	<b>CONNECTIONS .....</b>	<b>70</b>
Protect .....	61	Connecting to a Computer .....	70
Delete .....	62	Setting the USB Mode .....	70
DPOF (Digital Print Order Format) .....	63	Transferring files to your computer .....	70
Trim.....	64	Video System.....	71
Setup Menu.....	65	Set Eye-Fi SD Card Connection Mode .....	72



Connecting to a PictBridge Compatible Printer	73
Setting the USB Mode .....	73
Connecting to your Printer .....	74
Using the PictBridge Menu.....	75
Print (with Date).....	75
Print (without Date).....	76
Print Index.....	77
Print DPOF Images.....	78
Exit.....	78

## APPENDICES ..... 79

Specifications .....	79
Prompts and Warning Messages .....	83
Troubleshooting .....	87

# GETTING READY

## Accessories Included

Your camera box should contain the camera model you purchased along with the following accessories. If anything is missing or appears to be damaged, please contact your retailer.

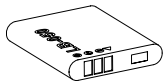

Rechargeable Li-ion  
battery



Wrist Strap

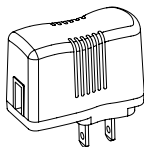

AC adapter

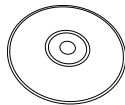

CD-ROM

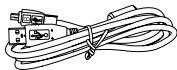

USB cable



Warranty card



Quick start guide



Service card

## Part Names

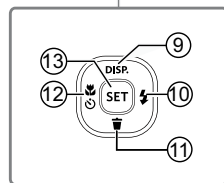
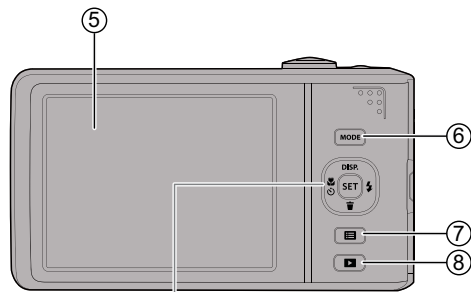
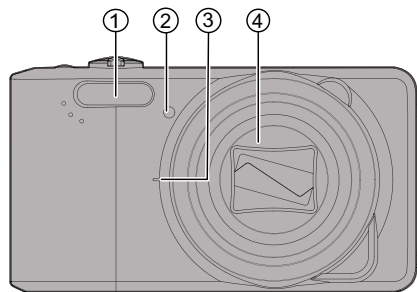

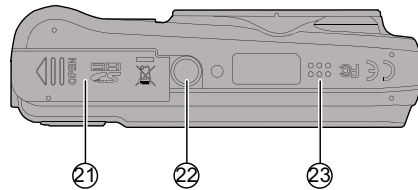
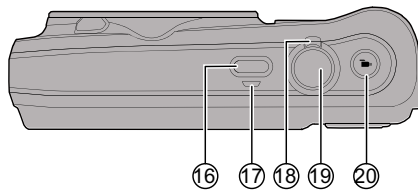
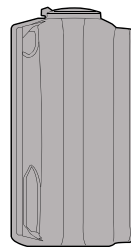
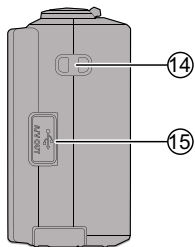

1	Flash Lamp	9	Display Button/ Arrow Button (Up)	17	Status Indicator
2	AF Assist Beam/Timer Indicator	10	Flash Button/ Arrow Button (Right)	18	Zoom lever
3	Microphone	11	Delete Button/ Arrow Button (Down)	19	Shutter Button
4	Lens	12	Macro Button/Self-Timer Button/Arrow Button (Left)	20	Fast Video Recording Button
5	LCD Screen	13	SET Button	21	Battery Cover
6	Mode Selection Button	14	Wrist Strap Buckles	22	Tripod Receptacle
7	Menu Button	15	USB Port	23	Speaker
8	Playback Button	16	Power Button		

## Installing Battery and Memory Card

1. Open the battery cover.

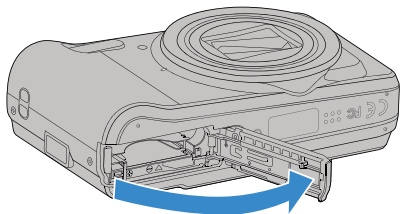
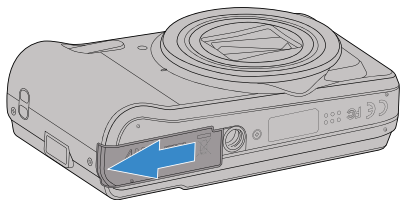

2. Insert the battery into the battery slot in the correct position as shown in the following diagram:

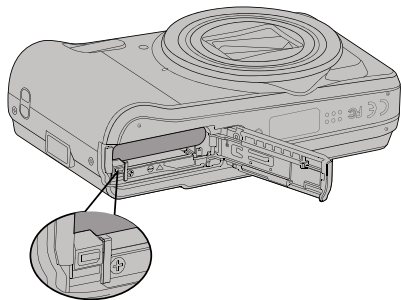
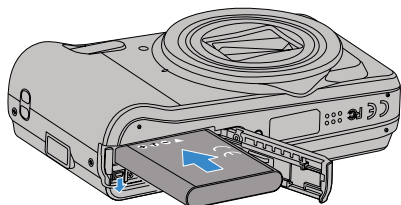

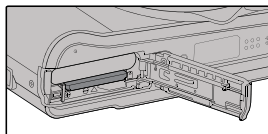
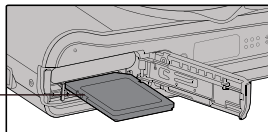

3. Insert the memory card into the memory card slot as shown in the diagram below:

Write protection buckle

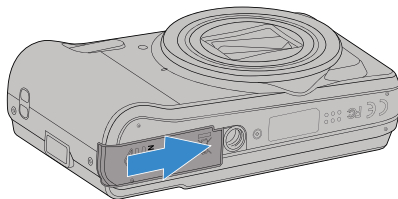
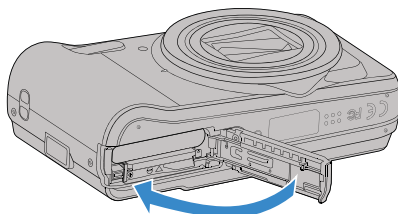

4. Close the battery cover.



 The memory card (SD/SDHC) is optional and not included in all camera packaging. If you have to purchase a memory card, select one with storage capacity between 4GB and 32GB to ensure correct data storage.



 To remove your memory card, open the battery cover, gently press the memory card to eject it and remove it carefully.

## Charging Battery

Before charging the battery, ensure that the battery is inserted properly and the camera is off.

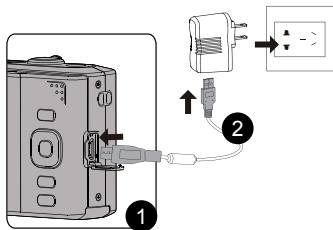

1. Connect the camera and the power charger using the supplied USB cable. (The plug shape of the power charger may vary depending on the country or region. The actual item may vary from the drawing below).
2. Insert the plug of the power charger into the wall outlet to charge the battery.

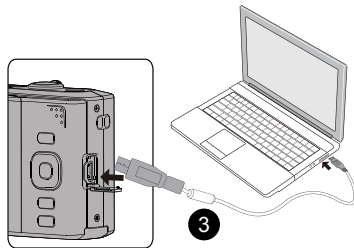

-  The charger is for indoor use only.
-  After the battery is stored for a long period of time, use the supplied power charger to charge the battery prior to use.
-  The indicator will go out once charging is finished, and the camera will be powered off automatically.

3. When the camera is turned off, you can also connect the camera to your PC using a USB cable to charge the battery.



-  Charging indicator:  
Red: Charging  
Green: Charging complete  
To have maximum battery life, charge the battery for at least 4 hours the first time.
-  Charging the battery should only be done with the camera in the "off" position.
-  Please charge the battery indoors between 0°C and 40°C.



## Turning Camera On and Off

Press the Power button to turn the camera on. To turn the camera off, press the Power button again.

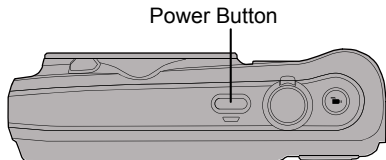

## Symbol Description

In the instructions below, the following symbols may be used throughout this manual on how to operate the camera. This is to facilitate better understanding.

[Item properties] : The option properties in the camera interface are indicated by the symbol [ ] .

## Set your Language, Date/Time

### Set your Language, Date/Time after the first power-on

1. When you turn the camera on for the first time, the language selection screen appears.
2. Press the arrow buttons to select your desired language.
3. After you press the **SET** button to confirm the selection, the Date/Time settings screen appears.
4. Press the left/right arrow button to select the Date/Time to be adjusted: Time is displayed in YYYY.MM.DD HH:MM.
5. Press the up/down arrow button to adjust the value for the selected Date/Time.
6. Press the **SET** button to confirm the time settings and the snapshot screen appears.

### Resetting your Language

After you set your language for the first time, follow the instructions below to reset your language.

1. Press the Power button to turn the camera on.



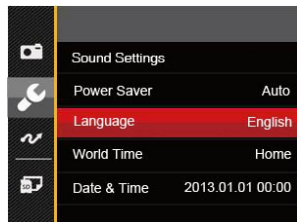



2. Press the **MENU** button, press the up/down arrow button to select **SETTINGS**, and press the **SET** button to enter the menu.
3. Press the up/down arrow button to select **LANGUAGE**, and press the **SET** button or right arrow button to enter the menu.
4. Press the up/down arrow button to select [Language] and press the **SET** button or right arrow button to enter the menu.
5. Press the arrow buttons to select your desired language and press the **SET** button to confirm.
6. Press the **MENU** button and the snapshot screen appears.







## Resetting Date/Time

After you set your Date/Time for the first time, follow the instructions below to reset date and time.

1. Press the Power button to turn the camera on.
2. Press the  button, press the up/down arrow button to select , and press the  button to enter the menu.
3. Press the up/down arrow button to select , and press the  button or right arrow button to enter the menu.
4. Press the up/down arrow button to select [Date & Time] and press the  button or right arrow button to enter the menu.
5. Press the left/right arrow button to select the Date/Time to be adjusted: Time is displayed in YYYY.MM.DD HH:MM.

6. Press the up/down arrow button to press the value for your selected block. After you finish your settings, press the  button to confirm.
7. Press the  button and the following snapshot screen appears.

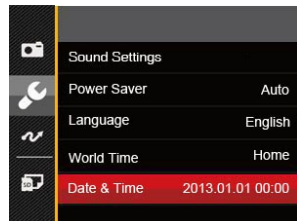

# MODE OVERVIEW

## Display Setting

Press the **DISP.** button to display the settings: Classic, Full, Off.

Classic: Displays the camera parameters on screen



Off: Does not display any additional icons on screen

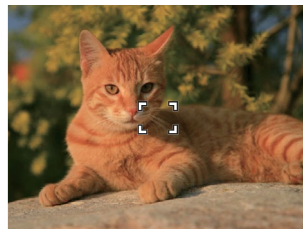

Full: Camera parameters with Grid and Histogram

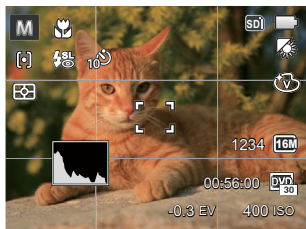



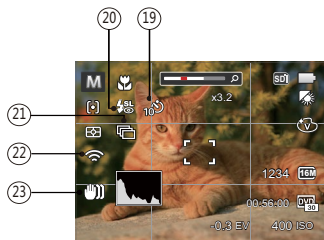
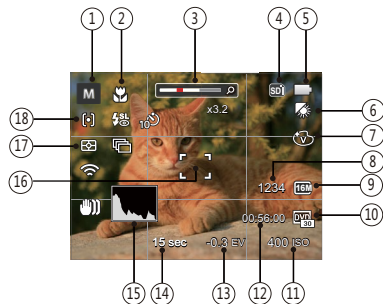

## LCD Screen Display

### Overview of the screen icons in photo shooting mode



#### 1 Shooting Mode Icons

-  Manual Mode
-  Panorama Mode
-  Auto Mode
-  Scene Mode
-  Portrait

#### 2 Macro Mode

#### 3 Zoom Display (By turning the Zoom Lever)

#### 4 SD Memory Card/Built-In Memory

#### 5 Battery Status

#### 6 White Balance (Adjustable only in Mode)

#### 7 Color Effect (Adjustable only in Mode)

#### 8 Number of remaining shots

#### 9 Image Size

#### 10 Video Quality

#### 11 ISO Value (Adjustable only in Mode)

#### 12 Remaining Recording time

#### 13 Exposure Compensation (EV value) (Adjustable only in Mode)

14 Shutter Speed (Adjustable only in  Mode)

15 Histogram

16 Focus Frame

17 Expo Metering



AiAE



Spot



Center

18 AF Mode



Single-AF



Multi-AF

19 Self-Timer



Self-timer Off



2 sec



10 sec



Smile

20 Flash Mode



Force Off



Flash Auto



Force Flash



Slow Sync.



Slow Sync. + Red-Eye



Red-Eye Reduction

21 Continuous Shot



Single



Continuous Shot



3 Shots



Time Lapse (30sec/1min/5min/10min)

22 Eye-Fi ON (with signal)

23 Image Stabilization

## Overview of the Screen Icons in Movie Mode

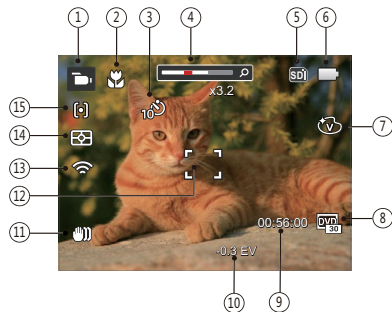

1 Movie Mode Icons

2 Macro Mode

3 Self-Timer



Self-timer Off



10 sec

4 Zoom Display (By turning the Zoom Lever)

5 SD Memory Card/Built-In Memory

6 Battery Status

7 Color Effect

8 Video Quality

9 Remaining Recording time

10 Exposure Compensation (EV value)

11 Image Stabilization

12 Focus Frame

13 Eye-Fi ON (with signal)

14 Expo Metering



AiAE



Spot



Center

15 AF Mode



For optimal video shooting, it is recommended that an SDHC memory card be used. If you shoot video using only the camera's internal memory, the end results may have image jitter, noise and vastly shorter recording times.



Optical Zoom and Digital Zoom can be adjusted. Digital Zoom can be adjusted to 6X (90X in total).

## Overview of the Screen Icons in Playback Mode

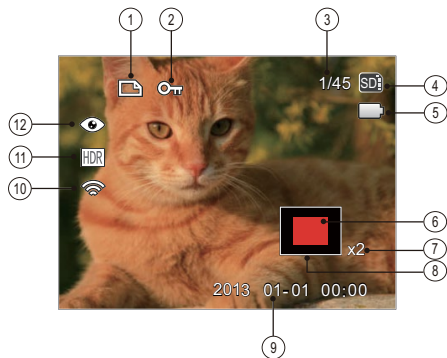







- 1 DPOF File
- 2 File Protection
- 3 Memory space (indicating the current number of photos and total number of photos)
- 4 SD Memory Card/Built-in Memory
- 5 Battery Status
- 6 Zoom Magnification Area
- 7 Image Zoom Ratios
- 8 Image Zone
- 9 Shooting Date
- 10 Eye-Fi ON (with signal)
- 11 HDR
- 12 Red-Eye Reduction



## Using the Mode Selection Button

This camera provides a convenient Mode Selection Button that allows you to switch easily between different modes. After pressing the Mode Selection Button to enter the mode selection menu, press the Left/Right button to choose the selected mode. Press the  button to confirm your selection. All the available modes are listed below:

Mode Name	Icon	Description
Manual Mode		Many of the camera settings can be configured manually in this mode.
Auto Mode		In this mode, the optimal conditions for taking pictures will be set based on the subject and environment. It is the most commonly used mode for taking pictures.
Portrait Mode		The best setting for portrait shooting, enables AE/AF for faces.
Panorama Mode		In this mode, up to 4 frames can be stitched together to create a single panoramic photo.
Scene Mode		Choose from 20 different pre-set scene types and effects for your photos.
Movie Mode		Record videos.

## Manual Mode M

When selecting manual ( **M** ) mode, you can set the aperture / shutter speed manually and ISO value.

1. Press the Mode Selection Button to select Manual Mode **M** , press **SET** button to confirm.

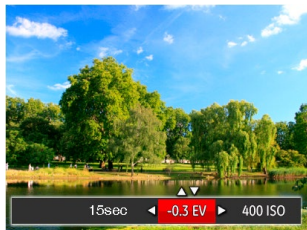

2. Press the left/right arrow button to select an adjustment setting.
3. Press the up/down button to adjust the parameters.
4. Press the **SET** button to confirm the settings and enter the shooting screen.

## Auto Mode

**Auto** Mode is the easiest mode to take photos. While operating in this mode, the camera automatically optimizes numerous camera settings to adjust your photos and videos for the best possible results.

Follow these steps:

1. Press the **MODE** button to select Auto Mode (  ).
2. Compose your picture in the LCD screen and press the Shutter button halfway down to focus on the subject.
3. The LCD screen will show a green focus frame when the subject is in focus.
4. Fully press the shutter button down to take pictures.

## Portrait Mode

In Portrait Mode, the camera is set to automatically adjust exposure for realistic capture of skin tones.

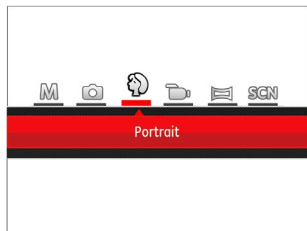

Press the Mode Selection Button to select Portrait mode (  ).

## Panorama Mode

Panorama Mode allows you to create a panoramic picture. The camera will automatically compose a panoramic picture using the individual shots that you take.

Follow these easy steps to create a panoramic picture:

1. Press **MODE** button to select Panorama Mode (  ).
2. Press the arrow buttons to select a shooting direction. (The right direction is used as default if you do not make any choice) 2 seconds later, the camera is ready to take pictures. You can also press the **SET** button or half press the shutter button to be ready to take pictures.
3. Compose the first view of the panoramic picture on the LCD screen and press the Shutter button to capture the image.
4. After the first shot is taken, the semi-transparent image of the first shot will appear at the edge of the screen. You can use this image to compose your picture before you press the Shutter button to capture and finish manual stitching.

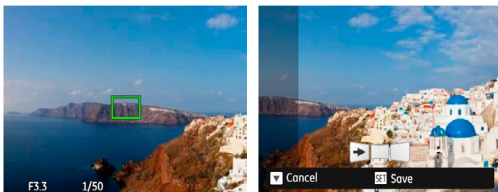

5. If continuous pictures are less than 4 shots, press **SET** button, the camera will splice the pictures automatically. Press playback button to enter playback mode to see the effect.
6. If you take 4 pictures, the camera will splice the pictures automatically. Press playback button to enter playback mode to see the effect.

- After selecting Panorama Mode, Flash, Self-timer, Macro Mode and Exposure Compensation cannot be adjusted.
- Pictures cannot be deleted, nor the zoom adjusted until the series is finalized.
- In Panorama Mode, up to 4 photos can be captured when the image size is set at 2MP.













## Scene Mode (SCN)









You can select an appropriate mode from the 20 scene modes according to the type of environment you are shooting. The camera then configures the most appropriate settings automatically.

Press the **MODE** button to enter Scene Mode. The LCD will display a menu like the example below:



Press the arrow buttons to select a scene , and press the **SET** button to confirm.







Scene	Description
 Auto Scene	Identifies the scene automatically; Person, Backlighting, Landscape, Macro, Night Scene, Night Scene Person, Auto.
 Landscape	For landscapes and outdoor shots. Vivid reproduction of green and blue.
 Sport	For fast-moving subjects. Capture sharp, action shots with minimal blur. This mode is not recommended for shooting indoors.
 Beach	For taking pictures in areas with strong sunlight.
 Sunset	For sunsets. Capture subjects in strong sunlight.
 Fireworks	For fireworks at night. Slower shutter speed is adjusted for brilliant images. The use of a tripod is recommended.
 Night Landscape	For night scenes. The use of tripod is recommended.
 Snow	For snow scenes. Reproduce natural, clear white scenes.
 Children	Turns off flash automatically. Avoids disturbing subject, suitable for taking photos of children.
 ID	For shooting ID size photos. (It is recommended to print using 6-inch 4R (6X4) photographic paper).
 Glass	For objects behind transparent glass.
 Photo Frame	For adding interesting frame effects to the photo.

Scene	Description
 Panning Shot	Suitable for capturing fast moving objects to have a clear subject with a blurred background.
 Sketch	For taking photos with pencil sketch effect.
 Fish Eye	For interesting fish eye effect.
 Party	Suitable for taking indoor party pictures, even under the complicated lighting conditions.
 Indoor	For indoor settings. Reduce blur and improve color accuracy.
 Leaf	For plants. Capture brilliant shots of greenery and blossoms.
 Museum	For museums or flash-free areas. Retain color and reduce blur.
 Night Portrait	For portraits against night scenery.

## Auto Scene Mode (ASCN)

In “ASCN” scene mode, the camera can detect different environments intelligently and automatically select the best scene and photo settings for you.

“ASCN” can intelligently detect the following scenes:

Icon	Mode Name	Icon	Mode Name
	Landscape Mode		Night Landscape Mode
	Portrait Mode		Macro Mode
	Night Portrait		Auto Mode
	Backlit Portrait		





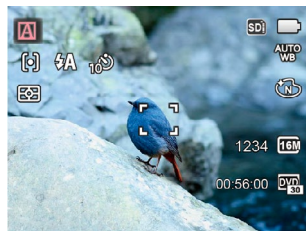

To use “ASCN”:

1. Press **MODE** button to select “SCN” mode, then select “ASCN” function. LCD screen will be shown as follows:



2. Hold the camera steadily and aim at the subject. The optimum scene mode will be selected automatically.
3. Press the shutter button half-way down to focus.
4. Press the shutter button all the way down to take pictures.



Mode Name	Description
 Landscape Mode	For landscapes, ASCN will automatically adjust the exposure and reproduce vivid green and blue colors.
 Portrait Mode	Most suitable for capturing people with focus on their faces.
 Night Portrait	When you take portraits at night, or in low light conditions, ASCN will automatically adjust the exposure for people and night scenes.
 Backlit Portrait	When the sun or any other light source is behind you, ASCN will automatically adjust the foreground exposure to produce the best pictures possible.
 Night Landscape Mode	For night scenes, ASCN will automatically increase the ISO value to compensate for low light.
 Macro Mode	To produce more detailed close-ups, ASCN will automatically engage the camera's Macro Mode and automatically focus the lens.
 Auto Mode	The camera will automatically adjust the exposure and focus to ensure the best possible pictures.

# BASIC OPERATION

## Using the Zoom Function

Your camera is equipped with two types of zoom functions: Optical Zoom and Digital Zoom. Toggle the Zoom lever of the camera to zoom in or out of the subject while taking pictures.

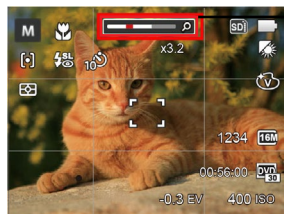
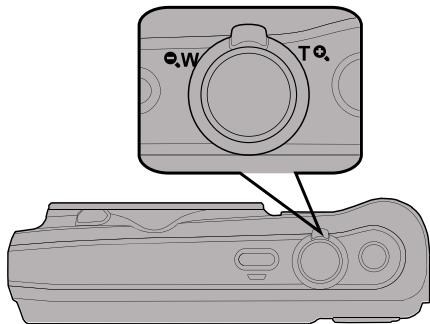



Zoom Indicator

When the Optical Zoom reaches the threshold as Digital Zoom, release and turn the zoom lever to T to switch between the Optical zoom and Digital zoom.



## Macro Mode

The Macro Setting is ideal for shooting small objects or close-up photos. This mode allows you to focus on subjects very close to the camera.

1. Press the left arrow button (   ) to enter the Macro Menu.





2. Press the left/right to select the following 2 modes:

-  **Macro Off**  
Select this option to disable Macro.
-  **Macro On**  
Select this to focus on subjects 3cm from the lens.

3. Press the  button to confirm the settings and exit the menu.



## Self-timer Setting



Use this function to take pictures at pre-set intervals. First choose 2 seconds, 10 seconds, or by smile detection. and then take the pictures.

1. Press the left arrow button (   ) to enter the self-timer menu.



2. Press left/right to select the following 4 modes:

-  Self-timer Off  
Disables the Self-Timer.
-  Self-timer 2sec  
A single picture is shot 2 seconds after the Shutter Button is pressed.

-  Self-timer 10sec  
A single picture is shot 10 seconds after the Shutter Button is pressed.
  -  Self-timer Smile  
Press the Shutter Button and a picture will be taken immediately after a smile is detected.
3. Press the  button to confirm the settings and exit the menu.



## Flash Mode





The Flash is used to illuminate a subject in low light or for fill-in lighting to achieve better illumination of a subject with pronounced shadows.

1. Press the right arrow button (  ) to enter the Flash Settings Menu.



2. Press the left/right to select the following 6 modes:

-  Force Off  
Flash is turned off.
-  Flash Auto  
Camera flash goes off automatically based on existing light conditions.
-  Force Flash  
The flash will engage with each shot even if there is enough available light to take the photo without flash.

-  Slow Sync.  
This allows for night scenery photos that include people in the foreground. The use of a tripod is recommended when shooting with this setting.
  -  Slow Sync. + Red-Eye  
Use this mode for slow synchro shots with red-eye reduction.
  -  Red-Eye Reduction  
The camera emits a brief pre-flash before the picture is taken to reduce red-eye effects.
3. Press the  button to confirm the settings and exit the option.

-  Please avoid the finger touch with the bumped part on the grip while using the camera, or your finger will shadow the flash to work.

## EV Setting

The EV function menu of the camera includes functions, such as EV, shutter adjustment, ISO. Using the appropriate function settings can improve your pictures.

To select the best setting for optimum photos, follow these steps:

1. Press the **SET** button to display the settings screen.
2. Press the left/right arrow button to select the setting options.



3. Press the up/down button to adjust the option values.
4. Press **SET** button to complete the setting and enter shooting mode.

## Exposure Compensation

Set up to adjust the picture brightness. In the case of a very high contrast between the photographed object and the background, the brightness of the picture can be appropriately adjusted. (Adjustable only in **M** Mode)

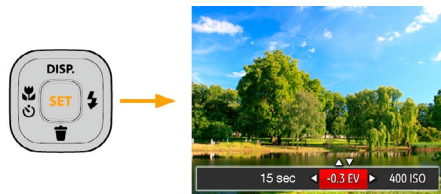

The adjustable range of exposure value is from EV -2.0 to EV+2.0.

## ISO

The ISO function allows you to set the sensitivity of the camera's light sensor based on the brightness of the scene. To improve the camera's sensor performance in darker environments, a higher ISO value is required. A lower ISO value is needed when shooting in brighter conditions.

Pictures taken at higher ISO settings will generally have more noise than those taken at lower ISO settings. (Adjustable only in  Mode)



The camera's ISO settings include: automatic, 80, 100, 200, 400, 800, 1600.

## Shutter Adjustment

You can adjust the shutter speed value. Selecting a higher shutter speed will capture fast moving objects more clearly. Selecting a slower shutter speed will result in some motion blur of moving objects. (Adjustable only in  Mode)



## Using Quick Recording

In shooting mode, press the Recording shortcut button (📹) to begin recording video.

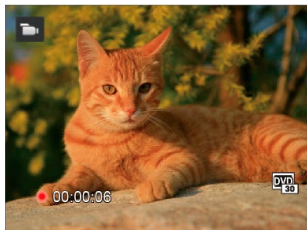

After finishing, press the Recording short cut button or the Shutter Button to stop and store the video. The camera will return to shooting mode automatically.



# PLAYBACK

## Viewing Photos and Videos

To view the captured photos and video clips on the LCD screen:

1. After pressing the **[ ]** button, the last photo or video clip taken will be displayed on the LCD screen.
2. Use the Left/Right navigation buttons to scroll through the photos or video clips stored in the internal memory or on the SD memory card.
3. To play a selected video clip, press the **[SET]** button to enter the Movie Playback Mode.

During video playback, the operating instructions will appear on the screen. Press the appropriate buttons, and press the **[SET]** button to engage the following actions:

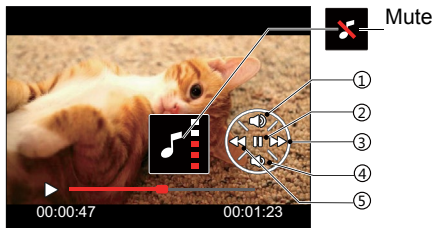

1	Increase Volume
2	Pause
3	Fast Forward
4	Decrease Volume
5	Rewind

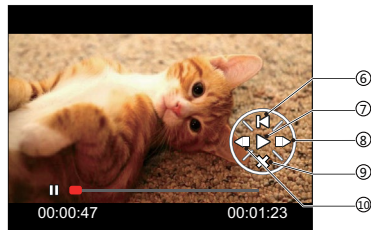

6	Back to the beginning of the video
7	Play
8	Play video forward
9	Cancel playback
10	Play video backward

## Thumbnail View

When in Playback Mode, rotate the Zoom lever counter clockwise to the **W** position to display thumbnail images of the photos and videos on the screen. **W** Zoom **T** Zoom In

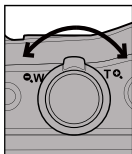

1. Slide the zoom lever to switch between 3x3 and 4x4 thumbnails.
2. When a 3x3 or 4x4 thumbnail is displayed, press the arrow buttons to select a picture or video clip to view.

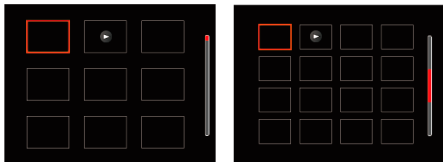



3. Press the arrow buttons to select a picture or video clip to view and press the **SET** button to restore it to the original size.

- ① If the **▶** indicator appears on the LCD, then a movie file is currently being displayed.
- ① Press the **SET** button to restore a preview icon to its original image size.

## Using Zoom Playback (for still pictures only)

The Zoom lever can also be used during playback. This allows you to magnify photos between x2 to x8.

1. Press the  button to switch to Playback Mode.
2. Press the left/right button to select a picture to be zoomed in.
3. Rotate the Zoom lever clockwise to (  ) to zoom in.
4. The bottom right corner of the screen will display the number of times and area of the photo zooming operation.

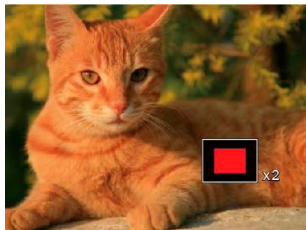



5. Press the arrow buttons to navigate and select a part of the image to be zoomed in.
6. Press the  button to return the image to its original scale.



Movie images cannot be magnified.

## Slideshow

This setting allows you to view all the stored images as a slideshow.

1. Press  button to enter playback screen.
2. Press  button to enter slide option.
3. Press the left/right button to select slideshow playing or 「Cancel」 to return to the playback screen.





4. Press the  button to confirm the setting.

## Photos and Video Deletion

In playback mode, press the down arrow button (  ) to delete your photos and videos.

To delete photos or videos:

1. Press the  button to switch to playback mode.
2. Press the left/right arrow button to select the photos and videos to be deleted.
3. Press the down arrow button (  ) and the deletion screen is displayed.

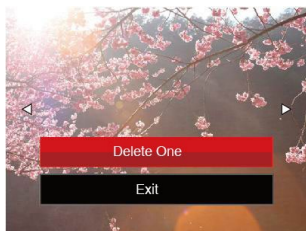

4. Press the up/down arrow button to select [Delete One] or [Exit] and press the  button to confirm.



Erased photos/video clips cannot be recovered.





Please refer to page 62 for instructions on deleting more than one image at a time.

# USING THE MENUS

## Photo Setup Menu

Mode:  **M**  **SCN**

1. In Photo Shooting Mode, press the  button to enter the Photo Shooting Menu.
2. Press the up/down arrow button to select the Photo Shooting Menu to be set.
3. Press the left/right arrow button to select the Photo Shooting Menu to be set and press the  button to confirm.

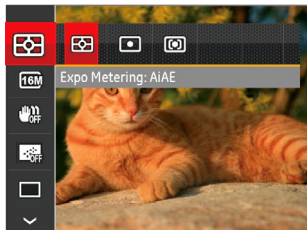

 Refer to the following pages for more details about each setting.

## Expo Metering (Exposure Metering)

Use this setting to select the "target" size of the camera's field of view to be metered.

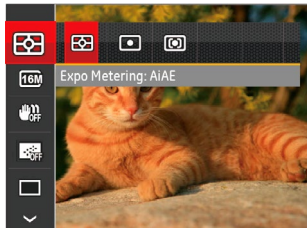

There are 3 options:

- AiAE (Artificial Intelligence AE) targets the camera's entire field of view.
- Spot metering targets a small area in the center of the camera's field of view.
- Center metering targets a slightly larger area in the center of the camera's field of view.

 AiAE (Artificial Intelligence AE): Automatically selects the central and peripheral metering, to calculate the reasonable value of metering by weighting.

## Image Size

The size setting refers to the image resolution in pixels. A higher image resolution allows you to print that image in larger sizes without degrading the image quality.

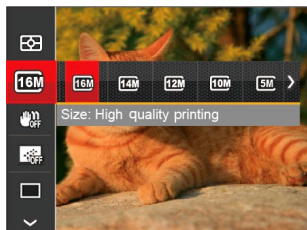

- ① The bigger the number of recorded pixels is, the better the image quality becomes. As the number of recorded pixels lessen, you will be able to record more images on a memory card.

## OIS

This mode can help reduce photo blur caused by unintentional hand shake, low light or slow shutter speed.

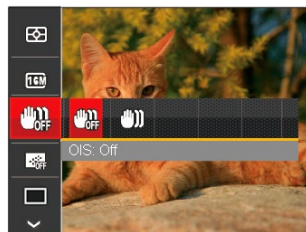

- ① Use Stabilization Mode in dark environments or when using a slower shutter speed.
- ① Shooting in a windy or unstable environment (such as a moving vehicle) may cause blurred images.

## Cont. AF

Enable the continuous AF to be able to continuously focus automatically when taking pictures.



There are 2 options:

- Off
- On

## Continuous Shot

Use this setting to perform continuous shooting. After entering this mode, you can shoot multiple images by continuously holding the shutter button down.

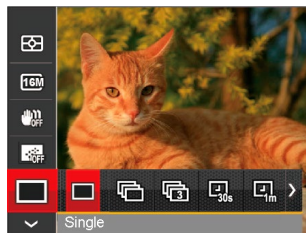



There are 7 options:

-  Single
-  Continuous Shot
-  3 Shots



-  Time-Lapse 30sec
-  Time-Lapse 1min
-  Time-Lapse 5min
-  Time-Lapse 10min

 The flash is disabled in this mode in order to achieve quick succession of shots.



 Press the Shutter button to start continuous shooting.

## Focus Setting

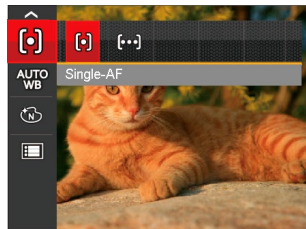
This setting allows you to select different modes for optimum focus.



There are 2 options:







-  Single-AF: The focus frame appears on the center of the LCD screen to focus on the subject.
-  Multi-AF: The camera automatically focuses the subject in a wide area to find the focus point.

## White Balance Setting

The White Balance Setting allows you to adjust the color temperature for different lighting sources to ensure the most accurate color reproduction.



There are 7 options:

-  AWB
-  Daylight
-  Cloudy
-  Fluorescent
-  Fluorescent CWF
-  Incandescent
-  Manual WB (Fully press the shutter button to detect the white balance value)

## Color Effect

The Image Color Setting allows you to select different color effects.



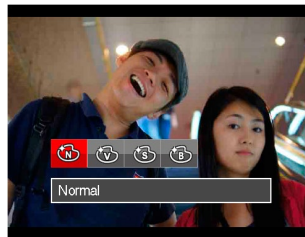









1. Press the  button to select the Image Color Setting Menu.
2. Press the left/right arrow button to select the Image Color Setting options.



There are 4 options:



-  Normal
-  Vivid
-  Sepia
-  Black and White

- Shooting menu in the shooting mode (O: Optional X: Not optional)





Options	Shooting Modes					
	M					SGN
	O	O	O	O	X	O
	O	O	O	O	X	O
	O	O	X	O	X	X
	O	O	O	X	X	X
	O	O	O	X	X	X
	O	O	X	X	X	X
	O	X	X	X	X	X
	O	X	X	O	X	X
	X	X	X	X	X	O

## Photo Shooting Setting Menu

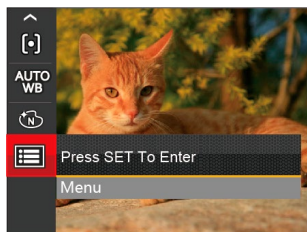
Mode:  **M**   **SCN**

1. Press the  button in Photo Shooting Mode and press the up/down button to select .



2. Press the  button to enter the menu.
3. Press up/down arrow button to select , and press the  button or right arrow button to enter the menu.
4. Press the up/down arrow button to select the item to be set and press the  button or right arrow button to enter the menu.
5. Press the up/down arrow buttons to select an option and press the  button to confirm.

### Quality

The Quality Setting can be used to adjust the image compression ratio.

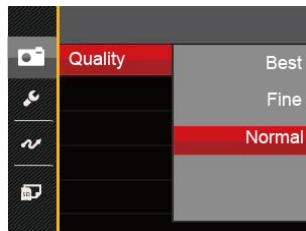

There are three options for picture quality:

- Best (16M Average File Size: 4.0MB)
- Fine (16M Average File Size: 2.5MB)
- Normal (16M Average File Size: 2.0MB)

## AF-Assist Beam

In a darker environment, AF Assist Beam can be turned on for better focus.



## Digital Zoom

Turn on or off the digital zoom.



## Date Imprint

Include a Date/Time stamp on the photo image.

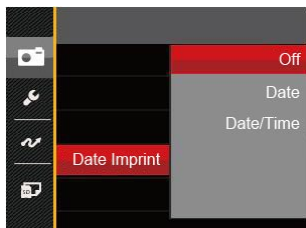

- Off
- Date
- Date / Time

## Quick Review

This option allows quick review of the photos immediately after they are taken. Each photo is displayed on the LCD screen based on the selected time.

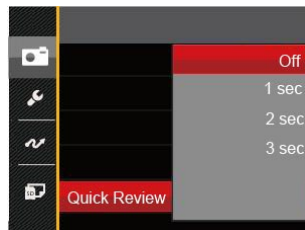



There are 4 options:

- Off
- 1 sec
- 2 sec
- 3 sec

## Movie Menu

Mode: 

1. Press the  button, select the  mode and press the  button to enter the Movie Menu.



2. Press the up/down arrow button to select the Movie Menu to be set.
3. Press the left/right arrow button to select the Movie Menu to be set and press the  button to confirm.

## Expo Metering (Exposure Metering)

Use this setting to select the "target" size of the camera's field of view to be metered.



There are 3 options:

- AiAE (Artificial Intelligence AE) targets the camera's entire field of view.
- Spot metering targets a small area in the center of the camera's field of view.
- Center metering targets a slightly larger area in the center of the camera's field of view.



AiAE (Artificial Intelligence AE): Automatically selects the central and peripheral metering, to calculate the reasonable value of metering by weighting.

## Video Quality

Set the image resolution used during video recording.

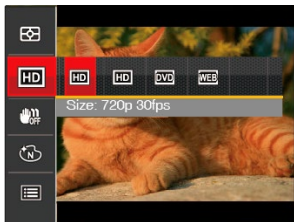

The speed requirements for reading and writing high image pixel images to SD card are as follows:

No.	Image Pixel	Frame	Recommendation	Recording time (4GB) About
1	1280x720 *	30	Class 4	15 minutes
2	1280x720	15	Class 4	31 minutes
3	640x480	30	Class 4	47 minutes
4	320x240	30	Class 4	201 minutes



 \* The longest recording time is 29 minutes at one time.

 When recording in higher pixel resolutions for extended periods of time, this can cause the camera to generate heat. This is not a camera malfunction.

## OIS

This mode can help reduce photo blur caused by unintentional hand shake, low light or slow shutter speed.



-  Use Stabilization Mode in dark environments or when using a slower shutter speed.
-  Shooting in a windy or unstable environment (such as a moving vehicle) may cause blurred images.





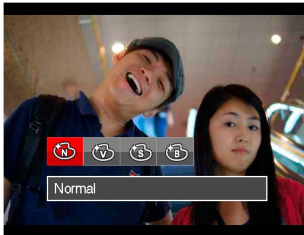

## Color Effect

The Image Color Setting allows you to select different color effects.

1. Press the **SET** button to select the Image Color Setting Menu.
2. Press the left/right arrow button to select the Image Color Setting options.





There are 4 options:

-  Normal
-  Vivid
-  Sepia
-  Black and White

## Movie Setting Menu

Mode: 

1. Press the **MODE** button, and select  to enter the video recording screen.
2. Press the  button, press the up/down arrow button to select , and press the **SET** button to enter the menu.

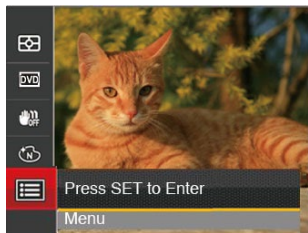

3. Press up/down arrow button to select , and press the **SET** button or right arrow button to enter the menu.
4. Select the items to be set and press the **SET** button or the right arrow button to enter the menu.
5. Press the up/down arrow buttons to select an option and press the **SET** button to confirm.



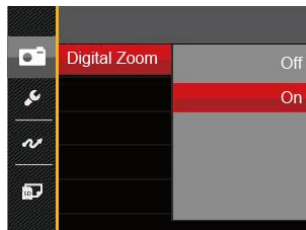

### Digital Zoom

Turn on or off the digital zoom.



## Playback Menu

Mode: 



1. Press the  button to display the playback screen and press  button to enter the menu.
2. Press the up/down arrow button to select the playback to be set and press  button to enter.
3. Press the left/right arrow buttons to select an option and press the  button to confirm.





Refer to the following pages for more details about each setting.

### HDR

With the HDR function, pictures that are overexposed may be corrected to optimize the highlights and lowlights captured to more accurately represent the actual scene.

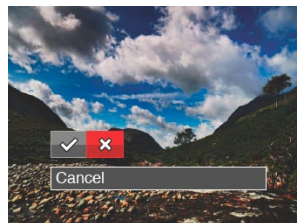
1. In Playback Mode, press the left /right arrow button to select the photos to be edited.
2. Press the  button, select the  settings, and press the  button to display the settings screen.
3. Press the left/right button to select whether HDR is used.





 : HDR



 : Cancel

4. After using the HDR function, the image will be saved as a new file and the original file is still stored in the memory.

## Red-Eye Reduction

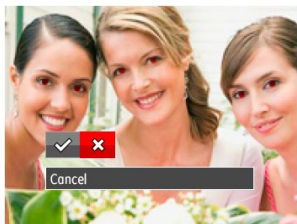
1. In Playback Mode, press the left /right arrow button to select the photos to be edited.
2. Press the  button, select the  settings, and press the  button to display the settings screen.
3. Press the left/right button to select the corresponding menu or [Cancel] to return to the playback screen.





-  : Red-Eye Reduction  
 : Cancel



4. Press the  button to confirm the setting.

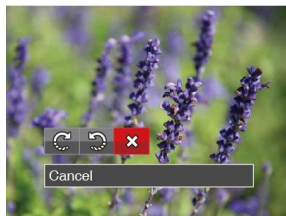

## Rotate

You can use this setting to change the orientation of the picture.

1. In Playback Mode, press the left /right arrow button to select the photos to be edited.
2. Press the  button, select the  settings, and press the  button to display the settings screen.
3. Press the left/right button to select the rotation direction or [Cancel] to return to the playback menu.





-  : Turn Right  
 : Turn Left  
 : Cancel

4. Press the  button to confirm the setting.
-  Videos and panoramic pictures cannot be rotated.  
 The rotated picture file will replace the original photo.

## Resize

This setting allows you to resize a picture to a particular resolution and saves it as a new picture.



1. In Playback Mode, press the left /right arrow button to select the photos to be edited.
2. Press the  button, select the  settings and press the  button to display the settings screen.
3. Press the left/right arrow button to select [1024X768] or [640X480] or select [Cancel] to return to the playback menu.





4. Press the  button to confirm the setting.

## Color Effect

This setting allows you to change the picture color effect. The file is saved as a new photo and stored in memory together with the original photo.

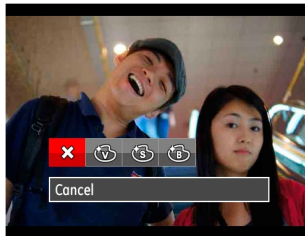
1. In Playback Mode, press the left /right arrow button to select the photos to be edited.
2. Press the  button, select the  settings, and press the  button to display the settings screen.
3. Press the left/right button to select the corresponding menu or [Cancel] to return to the playback screen.



4. Press the  button to confirm the setting.

 : Cancel





 : Sepia

 : Vivid



 : Black and White

## Playback Setting Menu

Mode: 

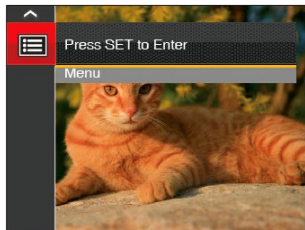
1. Press the  button to show the playback screen, press the  button, and press the up/down button to select  .
2. Press the  button to enter the menu.



3. Press up/down arrow button to select  , and press the  button or right arrow button to enter the menu.
4. Press the up/down arrow button to select the item to be set and press the  button or right arrow button to enter the menu.

5. Press the up/down arrow buttons to select an option and press the  button to confirm.

Refer to the following pages for more details about each setting.

### Protect

To prevent any pictures or videos from being accidentally erased, use this setting to lock one or all of the files.

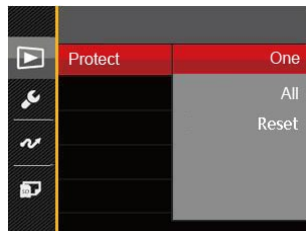

To lock or unlock the photo and video files:

1. Press the up/down arrow button to select [Protect] and press the  button or right arrow button to enter the sub-menu.

2. Press the up/down arrow button to select the sub-menu and press the **SET** button or right arrow button to show the settings screen.

There are 3 sub menus available:

- One: Lock the selected photo or video if they are unprotected; unlock the selected photo or video if they are protected.
  - All: Lock all photos or videos.
  - Reset: Cancel all locked photos or videos.
3. Press the up/down arrow buttons to select an option and press the **SET** button to confirm.

## Delete

You can delete one or all photo/video files.

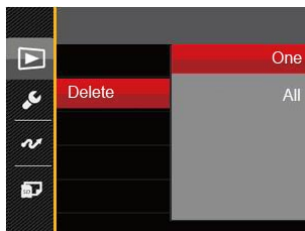



To delete photo or video files:

1. Press the up/down arrow button to select [Delete] and press the **SET** button or right arrow button to enter the submenu.
2. Press the up/down arrow button to select the submenu and press the **SET** button or right arrow button to show the settings screen.

There are 2 sub menus available:

- One: Delete one photo or video.
- All: Delete all photos or videos.

3. Press the up/down arrow buttons to select an option and press the **SET** button to confirm.

 The “” indicator means a file is protected. File protection must be removed first before a file can be deleted.

 Deleting files will cause DPOF settings to be reset.

## DPOF (Digital Print Order Format)

The DPOF feature allows you to compile and select a group of pictures that you would like to print and will save your selection on the memory card so that you can use the SD memory card to print without having to individually specify the photos you want to print.

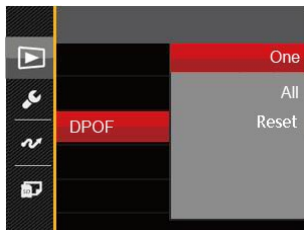

 The printer that supports DPOF is needed for printing.



## Trim

The Trim Setting allows you to crop photos and save them as new pictures.

1. Press the up/down arrow button to select [Trim] and press the **SET** button or right arrow button to enter the menu.
2. Select [Yes] to confirm trim. Select a part to be trimmed using the zoom lever and arrow buttons to trim a photo.

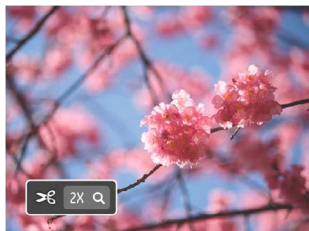





3. Press the **SET** button and the [Save change?] prompt appears. Select **[✓]** to change and save the picture. Select **[✗]** to cancel changes and return to the trim prompt screen.





The image cannot be clipped/trimmed again once it has been clipped to 640X480.

## Setup Menu

**Mode :**     **SGN**  

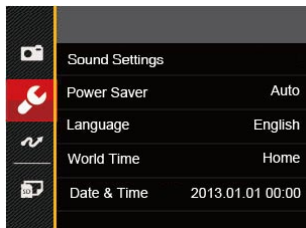
1. Press the  button in any mode and press the up/down button to select .
2. Press the  button to enter the menu.
3. Press up/down arrow button to select , and press the  button or right arrow button to enter the menu.



4. Press the up/down arrow button to select the item to be set and press the  button or right arrow button to enter the menu.
5. Press the up/down arrow buttons to select an option and press the  button to confirm.

Refer to the following pages for more details about each setting.

## Sound Settings

To change this setting:

1. Select [Sound Settings] in the basic settings menu. Press the **SET** button or right arrow button to enter the menu.
2. Press the left/right arrow button to select an option.

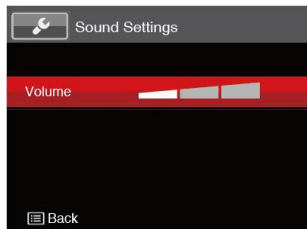

3. Press the **SET** button to confirm.

## Power Saver

This setting allows you to save power and get the maximum possible running time for your camera's batteries. Follow the steps below to turn the LCD screen and camera off automatically after a consecutive period of inactivity.

1. Select [Power Saver] in the basic settings menu. Press the **SET** button or right arrow button to enter the menu.
2. Press the up/down arrow button to select an option.

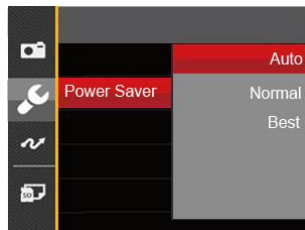



3. Press the **SET** button to confirm.

## Language

Refer to the "Reset your language" section on page 17.

## Zone

The Zone setting is a useful function for your overseas trips. This feature enables you to display the local time on the LCD screen while you are abroad.

1. Select [World Time] in the basic settings menu. The World Time screen appears.
2. Press the up/down to select the departure place (  ) and destination (  ) fields.
3. Press the left/right arrow button to select a city located in the same time zone as that of the field. Press the  button to confirm settings.



## Date/Time







Refer to the “Reset Date/Time” section on page 18.

## File / Software

### Format Memory

Please note: formatting enables you to delete all contents in the memory card and built-in memory, including protected photo and movie files.

To use this setting:

1. Press the  button, press the up/down arrow button to select  and press the  button to enter the menu.
2. Press up/down arrow button to select  and press the  button or right arrow button to enter the menu.
3. Press the up/down arrow button to select [Format] and press the  button or right arrow button to enter the menu.
4. Press the up/down arrow buttons to select [Yes] or [No] and press the  button to confirm.

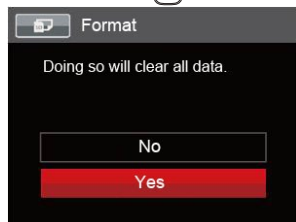

5. If you select [Yes] the camera formats its memory.



Note that when you perform the Format Memory function, it only formats the active memory. If an SD memory card is inserted, the SD memory card is active and will be formatted. If there is no SD memory card, the internal memory is active and the internal memory will be formatted. Formatting the SD memory card will not automatically format the internal memory.

### Copy to Card

Use this setting to copy the files stored in the internal memory to an SD memory card.

1. Press the button, press the up/down arrow button to select and press the button to enter the menu.
2. Press up/down arrow button to select and press the button or right arrow button to enter the menu.
3. Press the up/down arrow button to select [Copy to Card] and press the button or right arrow button to enter the menu.
4. Press the up/down arrow buttons to select [Yes] or [No] and press the button to confirm.



If there is no card available in the camera, this function will not be displayed.

### File Numbering







After you take a picture or video clip, the camera will save it with a sequential number. You can use this to reset the file numbering to 1.

1. Press the button, press the up/down arrow button to select and press the button to enter the menu.
2. Press up/down arrow button to select and press the button or right arrow button to enter the menu.
3. Press the up/down arrow button to select [File Numbering] and press the button or right arrow button to enter the menu.
4. Press the up/down arrow buttons to select [Yes] or [No] and press the button to confirm.



## Reset







Use this setting to restore the camera to its original default settings.

1. Press the  button, press the up/down arrow button to select  and press the  button to enter the menu.
2. Press up/down arrow button to select  and press the  button or right arrow button to enter the menu.
3. Press the up/down arrow button to select [Reset] and press the  button or right arrow button to enter the menu.
4. Press the up/down arrow buttons to select [Yes] or [No] and press the  button to confirm.



## FW Version

Use this setting to view the current camera firmware version.

1. Press the  button, press the up/down arrow button to select  and press the  button to enter the menu.
2. Press up/down arrow button to select  and press the  button or right arrow button to enter the menu.
3. Press the up/down arrow button to select [FW Version] and press the  button or right arrow button to enter the menu.









4. When there is a new firmware version in the SD card, select [Yes] to update.

## Connecting to a Computer

You can use a USB cable to connect the camera and copy (transmit) photos to a computer, printer or other device.

### Setting the USB Mode

The camera's USB port can be set to connect with either a computer or a printer. The following steps will allow you to ensure that the camera is correctly configured to connect with a PC.

1. Press the  button, press the up/down arrow button to select  and press the  button to enter the menu.
2. Press up/down arrow button to select  and press the  button or right arrow button to enter the menu.
3. Press the up/down arrow button to select [USB] and press the  button or right arrow button to enter the menu.
4. Press the up/down arrow buttons to select [PC] and press the  button to confirm.



### Transferring files to your computer

The computer will automatically detect the camera as a removable drive. Double-click the My Computer icon on the desktop to locate the removable drive and to copy folders and files in the drive to a directory on your PC as you would copy any typical folder or file.

Follow the steps below to connect the camera to a computer.

1. Make sure both the camera and computer are turned on.
2. Connect one end of the supplied USB cable to the USB/AV OUT port on your camera.



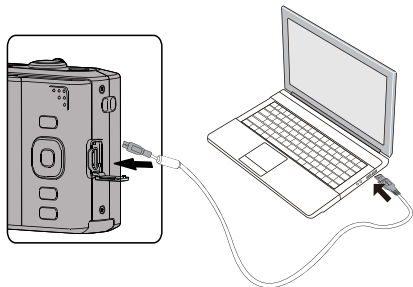



3. Connect the other end of the cable to an available USB port on your computer.



4. After the transmission is complete, disconnect the USB cable according to the instructions specifying how to safely remove USB devices.

## Video System

Use this feature to switch the video system from either NTSC or PAL.

1. Press the  button, press the up/down arrow button to select  and press the  button to enter the menu.
2. Press up/down arrow button to select  and press the  button or right arrow button to enter the menu.
3. Press the up/down arrow button to select [TV-System] and press the  button or right arrow button to enter the menu.
4. Press the up/down arrow buttons to select [NTSC] or [PAL] and press the  button to confirm.

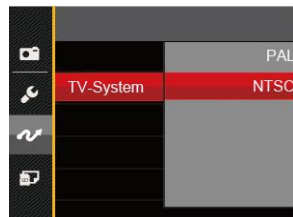



The video output signal can be switched to NTSC or PAL to accommodate different regional TV standards. The appropriate setting will vary between regions.







**NTSC:** USA, Canada, Taiwan, Japan, etc.

**PAL:** Europe, Asia (excluding Taiwan), Oceania, etc.

**Note:** The TV output will not display properly if an incorrect video system is selected.

## Set Eye-Fi SD Card Connection Mode

This camera supports wireless connection of an Eye-Fi SD Card. Upload the photos from the camera to the Internet using the following steps:

1. Press the  button, press the up/down arrow button to select  and press the  button to enter the menu.
2. Press up/down arrow button to select  and press the  button or right arrow button to enter the menu.
3. Press the up/down arrow button to select [Eye-Fi] and press the  button or right arrow button to enter the menu.
4. Press the up/down arrow buttons to select [On] or [Off] and press the  button to confirm.

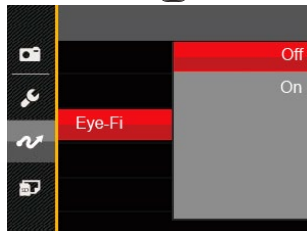

 If the Eye-Fi card is not available in the camera, this feature is not displayed.

## Connecting to a PictBridge Compatible Printer









PictBridge technology allows printing of the photos saved in the memory card by the printer.

To find out if a printer is PictBridge compatible, simply look for the PictBridge logo on the packaging or check the owner's manual for specifications. With the PictBridge function on your camera, you can print the captured photos directly to a PictBridge compatible printer using the supplied USB cable, without the need for a PC.

### Setting the USB Mode

The camera's USB port can be set to connect with either a PC or a Printer, the following steps will ensure that the camera is correctly configured to connect with a Printer.

1. Press the  button, press the up/down arrow button to select  and press the  button to enter the menu.
2. Press up/down arrow button to select  and press the  button or right arrow button to enter the menu.
3. Press the up/down arrow button to select [USB] and press the  button or right arrow button to enter the menu.
4. Press the up/down arrow buttons to select [Printer] and press the  button to confirm.



 After the camera is reset, it will switch to PC mode automatically from USB mode.

 See "PictBridge" section on page 75.

## Connecting to your Printer

1. Make sure both the camera and printer are turned on.
2. Connect one end of the supplied USB cable to the USB port on your camera.
3. Connect the other end of the cable to the USB port on the printer.

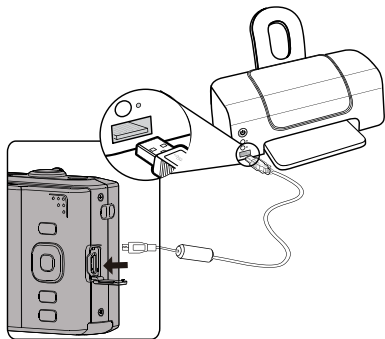

If the camera is not connected to a PictBridge compatible printer, the following error message will appear on the LCD screen.

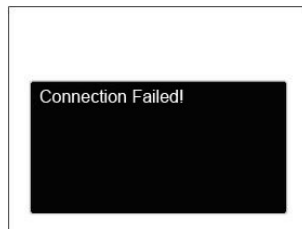

-  The error message above will also appear if the USB mode is set incorrectly, in which case you should disconnect the USB cable, check the USB mode settings, ensure that the Printer is turned on, and then try connecting the USB cable again.

## Using the PictBridge Menu

After setting the USB mode to Printer, the **PictBridge** Menu will appear.

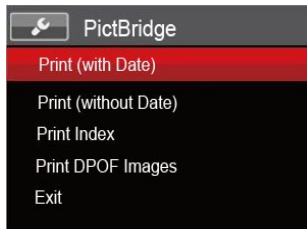

Press the up/down arrow button to select a menu item and press the **SET** button or right arrow button to enter the item.

Refer to the following sections for more detailed information on each setting.

### Print (with Date)

If you have set the date and time on your camera, the date and time will be recorded and saved with each photo you take.

1. In the PictBridge menu, select [Print (with Date)] and the screen as shown below appears.

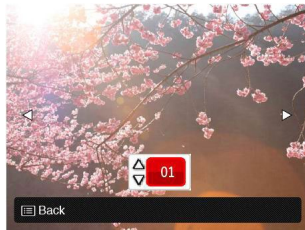

2. Press the left/right arrow button to select a photo to be printed.

3. Press the up/down arrow button to select the number of copies for the currently displayed photo.
4. Press the **SET** button and the following screen will appear.



5. Select [Yes] and press the **SET** button to confirm; select [Cancel] to cancel printing.

## Print (without Date)

Use this setting to print the photos without dates on them.

1. In the PictBridge menu, select [Print (without Date)] and the screen as shown below appears.



2. Press the left/right arrow button to select a photo to be printed.
3. Press the up/down arrow button to select the number of copies for the currently displayed photo.
4. Press the **SET** button and the following screen will appear.



5. Select [Yes] and press the **SET** button to confirm; select [Cancel] to cancel printing.

## Print Index

You can print all photos in the camera via this function.

1. In the PictBridge menu, select [Print Index] and the screen as shown below appears.

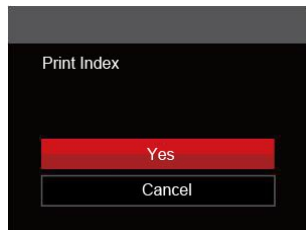

2. Select [Yes] and press the **SET** button to confirm; select [Cancel] to cancel printing.

## Print DPOF Images

To use DPOF printing, you must select your photos for printing using the DPOF settings beforehand. See “DPOF” section on page 63.

1. In the PictBridge menu, select [Print DPOF Images] and the screen as shown below appears.



2. Select [Yes] and press the **SET** button to confirm; select [Cancel] to cancel printing.

## Exit

Select [Exit] to exit the PictBridge menu. At this time, the message [Remove USB Cable!] appears on the screen.



Disconnect the USB cable from the camera and printer.

# APPENDICES

## Specifications



Design and specifications are subject to change without notice.

Effective Imaging Sensor Pixels		16.15 Megapixels
Total Image Sensor Pixels		16.44 Megapixels [1/2.3"CCD]
Lens	Focal Length	4.3mm (Wide) — 64.5mm (Tele)
	[35mm film equivalent]	[24mm (Wide) — 360mm (Tele)]
	F number	F3.3 (Wide) — F5.9 (Tele)
	Lens Construction	9 groups 10 elements
	Optical Zoom	15x
	Focusing Range	Normal: (Wide) 60cm ~ ∞ (Tele) 250cm ~ ∞ Macro: 3cm ~ ∞ (Wide Only)
Anti-Handshake		Optical Image Stabilization
Digital Zoom		6x Digital Zoom (Combined Zoom: 90x)



Number of Recording Pixels	Still Image	(4:3) 16MP: 4608×3456 10MP: 3648×2736 5MP: 2592×1944 3MP: 2048×1536 0.3MP: 640×480	(3:2) 14MP: 4608×3072	(16:9) 12MP: 4608×2592 2MP: 1920×1080
	Movie	720p30, 720p15, VGA, QVGA		
Image Compression		Best, Fine, Normal		
DCF, DPOF (Ver1.1) Support		Yes		
File Format	Still Image	Exif 2.3 (JPEG)		
	Movie	Movie Format: MOV (Motion JPEG), Audio: G.711 [Monaural]		
Shooting Modes		M, Auto, Portrait, Movie, Panorama, SCN [ASCN Scene, Landscape, Sport, Beach, Sunset, Fireworks, Night Landscape, Sketch, Snow, Children, ID, Glass, Photo Frame, Panning Shot, Night Portrait, Fish Eye, Party, Indoor, Leaf, Museum]		
Detection Features		Face, Smile, Blink		
Red-Eye Removal		Yes		
HDR		Yes(Post-Processing)		

Panorama	0°~ 180°(Horizontal)
LCD Display	3.0inch (230k Pixels)
ISO Sensitivity	Auto, ISO80/100/200/400/800/1600
AF Method	Single AF, Multi-AF (TTL 9-point), Face-Detection
Exposure Metering Method	Artificial Intelligence AE (AiAE), Center-Weighted Average, Spot (Fixed to Center of Frame), Face AE
Exposure Control Method	Program AE (AE-Lock Available)
Exposure Compensation	±2EV in 1/3 Step Increments
Shutter Speed	1/2000 ~ 4 Seconds (Manual: 30 Seconds)
Continuous Shooting	Yes
Playback Modes	Single Photo, Index (9/16 Thumbnails), Slide Show
	Zoom (Approx. x2~x8)
White Balance Control	AWB, Daylight, Cloudy, Fluorescent, Fluorescent CWF, Incandescent, Manual

Flash	Flash Method	Internal
	Flash Modes	Flash Auto, Red-Eye Reduction, Force Flash, Force Off, Slow Synchro, Red-Eye Reduction + Slow Synchro
	Shooting Range	(Wide) Approx. 0.5m ~ 4.7m (ISO800) (Tele) Approx. 1.0m ~ 2.6m (ISO800)
Recording Media		Internal Memory: Approx. 8MB
		SD/SDHC Card (Up to 32GB Support) [Nonsupport MMC Card]
Other Features		PictBridge, ExifPrint Support, Multi-Language Support (28 Languages)
Jacks		AV-OUT/USB 2.0 (Micro 5 pin USB)
Eye-Fi Support		Yes
Power		Rechargeable Li-ion Battery LB-052, 3.7 V 880mAh, In-Camera Charging
Shooting Capability (Battery Performance)		Approx. 210 Shots (Based on CIPA Standards)
Operation Environment		Temperature: 0 ~ 40°C, Humidity: 0 ~ 90%
Dimensions (W×H×D)		Approx. 108.2×59.7×30.9mm (Based on CIPA Standards)
Weight		Approx. 180g (Body Only)

## Prompts and Warning Messages

Message	Description	Action
Warning! Battery exhausted.	The camera battery is used up. It is a warning indicating that the camera is going to shut down.	Replace with new batteries. The camera will shut down in 2 seconds.
Lens obstruction, Re-start Camera.	The lens is jammed or some foreign object is preventing the lens from functioning properly.	Turn off the camera and restart it to reset the lens.
Battery temperature is too high.	The battery temperature reaches 53.5°C.	Let the battery cool before attempting to use the camera again. The message will disappear after 2 seconds
Built-in memory error!	An error occurs in internal memory.	Try shutting down the camera and turning it on again. The message will disappear after 2 seconds

Message	Description	Action
Warning! Do not turn off your camera during update!	The message appears during the firmware update process.	The message disappears after the camera update and restart.
Connection Failed!	Failure to connect to your PC, printer, TV.	Remove USB cable and retry connection
Slow access	When a SD card lower than Class 4 is used to record a HD movie, the writing speed will be slower and recording will not continue.	Replace SD card with a higher Class over 4. The message will disappear after 2 seconds.
Cannot write to SD card.	The photo shooting or video recording has been interrupted so recording cannot continue.	Turn off the camera. Then unload and reload the SD card and turn on the camera to retry. Also check if SD card is full or in a locked position.
No Red-Eye Detected!	Red eyes have not been detected in the image.	The message will disappear after 2 seconds.

Message	Description	Action
Write Protect !	The SD card is locked.	Remove SD card and switch the lever on the side of card to UNLOCK. The message will disappear after 2 seconds.
Card Full !	Indicates that the SD card is full.	Replace SD card with another that has available memory. The message will disappear after 2 seconds.
Memory Full !	Indicates that the camera memory is full.	It disappears after 2 seconds.
Card Error !	During power-on, the SD card cannot be recognized or a read/write error occurs.	Format the SD card. WARNING: Formatting the SD card will erase all data on the card. Copy the data from the SD card to another storage, such as a computer. Otherwise, all data will be erased after the format. The message will disappear after 2 seconds.
Card is not formatted.	When an error occurs in the SD card, the message "Not Formatted" appears.	Format the SD card. WARNING: Formatting the SD card will erase all data on the card. Copy the data from the SD card to another storage, such as a computer. Otherwise, all data will be erased after the format.

Message	Description	Action
This image cannot be edited.	The file format does not support editing or the edited file cannot be edited again.	The message will disappear after 2 seconds.
Exceeded maximum folder number.	This indicates that the SD card exceeded the maximum number of folders (999). This could cause a long read time during the camera's power up.	Copy the data to your PC, format the memory card using the camera.
Too many pictures for quick processing.	During the playback by date, the images exceed specifications so that it is not possible to play by date.	The message disappears after 2 seconds and the camera returns to the normal playback mode.
Unable to recognize files.	The format of the file to be viewed is not supported or the file is corrupted so it cannot be properly read.	This image message disappears only after the file is deleted.
No Picture!	When you press the play button, no image files exist in the camera or memory card.	The message disappears 2 seconds later to return to the photo shooting screen.
Protected! Undeletable!	The file is protected. The message appears when you delete it.	Remove SD card and switch the lever on the side of card to UNLOCK. Place back into the camera and try again. The message will disappear after 2 seconds.

## Troubleshooting

Problem	Possible causes	Solution
Camera does not turn on	<ul style="list-style-type: none"><li>■ The battery has been depleted.</li><li>■ The battery is not inserted correctly.</li></ul>	<ul style="list-style-type: none"><li>■ Recharge the battery.</li><li>■ Correctly reinstall the battery.</li></ul>
Camera turns off suddenly during operation	<ul style="list-style-type: none"><li>■ The batteries have been depleted.</li></ul>	<ul style="list-style-type: none"><li>■ Recharge the battery.</li></ul>
The picture is blurred	<ul style="list-style-type: none"><li>■ Camera shakes while taking a picture.</li></ul>	<ul style="list-style-type: none"><li>■ Turn on OIS feature.</li></ul>
Images and video files cannot be saved	<ul style="list-style-type: none"><li>■ The SD memory card is full.</li><li>■ The memory card is locked.</li></ul>	<ul style="list-style-type: none"><li>■ Use another memory card or delete unnecessary files.</li><li>■ Unlock the memory card.</li></ul>
Images will not print from the connected printer	<ul style="list-style-type: none"><li>■ The camera is not connected to the printer correctly.</li><li>■ The printer is not PictBridge compatible.</li><li>■ The printer is out of paper or ink.</li><li>■ The printer paper is jammed.</li></ul>	<ul style="list-style-type: none"><li>■ Check the connection between the camera and printer.</li><li>■ Use a PictBridge compatible printer.</li><li>■ Load paper into the printer or replace the ink cartridge in the printer.</li><li>■ Remove the jammed paper.</li></ul>



Problem	Possible Causes	Solution
Saving data to memory card is slow	<ul style="list-style-type: none"> <li>■ Using a memory card below Class 4 may result in slower recording times.</li> </ul>	<ul style="list-style-type: none"> <li>■ Use an SD card with write Class higher than 4 to improve performance.</li> </ul>
Cannot write to the memory card	<ul style="list-style-type: none"> <li>■ The SD memory card has been locked.</li> <li>■ The camera may experience trouble recording HD movies to SD cards with a rating lower than Class 4.</li> </ul>	<ul style="list-style-type: none"> <li>■ Release the write lock of the memory card or replace with another card.</li> <li>■ Use an SD card with write Class higher than 4 to improve performance.</li> </ul>
Too many movies to process	<ul style="list-style-type: none"> <li>■ The number of pictures or folders in the SD memory card exceed the specifications, so the playback can not be displayed.</li> </ul>	<ul style="list-style-type: none"> <li>■ Delete unwanted files.</li> </ul>



The Kodak trademark and trade dress are used under license from Kodak.

© 2013 JK Imaging Ltd. All Rights Reserved.

JK Imaging Ltd., 17239 So. Main Street, Gardena, CA 90248 USA

JK Imaging Europe, 71 Clarendon Road, Watford, WD17 1DS, UK

<http://kodakpixpro.com>